



H.264 Full-HD IP Camera

ICA-HM126 / ICA-HM126R

ICA-HM131 / ICA-HM131R

User's manual

Version 1.1

Copyright

Copyright (C) 2011 PLANET Technology Corp. All rights reserved.

The products and programs described in this User's Manual are licensed products of PLANET Technology, This User's Manual contains proprietary information protected by copyright, and this User's Manual and all accompanying hardware, software, and documentation are copyrighted.

No part of this User's Manual may be copied, photocopied, reproduced, translated, or reduced to any electronic medium or machine-readable form by any means by electronic or mechanical. Including photocopying, recording, or information storage and retrieval systems, for any purpose other than the purchaser's personal use, and without the prior express written permission of PLANET Technology.

Disclaimer

PLANET Technology does not warrant that the hardware will work properly in all environments and applications, and makes no warranty and representation, either implied or expressed, with respect to the quality, performance, merchantability, or fitness for a particular purpose.

PLANET has made every effort to ensure that this User's Manual is accurate; PLANET disclaims liability for any inaccuracies or omissions that may have occurred.

Information in this User's Manual is subject to change without notice and does not represent a commitment on the part of PLANET. PLANET assumes no responsibility for any inaccuracies that may be contained in this User's Manual. PLANET makes no commitment to update or keep current the information in this User's Manual, and reserves the right to make improvements to this User's Manual and/or to the products described in this User's Manual, at any time without notice.

If you find information in this manual that is incorrect, misleading, or incomplete, we would appreciate your comments and suggestions.

CE mark Warning

The is a class B device, In a domestic environment, this product may cause radio interference, in which case the user may be required to take adequate measures.

WEEE Warning



To avoid the potential effects on the environment and human health as a result of the presence of hazardous substances in electrical and electronic equipment, end users of electrical and electronic equipment should understand the meaning of the crossed-out wheeled bin symbol. Do not dispose of WEEE as unsorted municipal waste and have to collect such WEEE separately.

Trademarks

The PLANET logo is a trademark of PLANET Technology. This documentation may refer to numerous hardware and software products by their trade names. In most, if not all cases, their respective companies claim these designations as trademarks or registered trademarks.

Revision

User's Manual for PLANET H.264 Full-HD Box IP Camera

Model: ICA-HM126 / ICA-HM126R / ICA-HM131 / ICA-HM131R

Rev: 1.1 (2011, Jan)

Part No. EM-ICAHM126_131 Series v1.1

TABLE OF CONTENTS

Chapter 1 Introduction	6
Overview	6
Package Content	7
Physical Details	7
Top View – ICA-HM126 Series	7
Rear View – ICA-HM126 Series	8
Top View – ICA-HM131 Series	8
Side View – ICA-HM131 Series	10
Chapter 2 Preparations for IP Camera Setup	11
Physical Installation Requirement.....	11
2.1 System Requirements	11
2.2 Installation.....	11
2.2.1 ICA-HM126 Series Installation.....	11
2.2.2 ICA-HM131 Series Installation.....	13
2.3 Alarm Application (ICA-HM126 Series).....	13
Chapter 3 Accessing Camera.....	14
3.1 Device Search Software Setup.....	14
3.2 Device Search	15
3.3 Example of Changing IP Camera’s Network Property	16
3.4 Installing DC Viewer Software Online	17
3.5 Administrator / User Privileges.....	19
3.6 Lens Adjustment	19
ICA-HM131 Series Lens Adjustment.....	19
Chapter 4 Configuration & Operation.....	20
4.1 Browser-based Viewer Introduction.....	20
4.2 Home Page	21
4.3 System Related Settings.....	22
4.3.1 Host Name and System Time Setting	23
4.3.2 Security	24
4.3.3 Network.....	26
4.3.4 DDNS.....	28
4.3.5 Mail	29
4.3.6 FTP.....	30
4.3.7 HTTP Notification.....	31
4.3.8 Application (ICA-HM126 Series)	31
4.3.9 Motion Detection.....	34
4.3.10 Storage management	37

4.3.11	Recording	38
4.3.12	File location.....	39
4.3.13	Iris adjustment (ICA-HM126 Series)	39
4.3.14	View Log File.....	40
4.3.15	View User Information.....	40
4.3.16	View Parameters.....	42
4.3.17	Factory Default.....	42
4.3.18	Software Version	43
4.3.19	Software Upgrade.....	44
4.3.20	Maintenance	46
4.4	Video and Audio Streaming Settings	47
4.4.1	Video Resolution and Rotate Type	47
4.4.2	Video Compression	50
4.4.3	Video OCX Protocol	50
4.4.4	Video Frame Skip.....	51
4.4.5	Audio Mode and Bit Rate Settings.....	52
4.5	Camera Settings	53
4.5.1	Exposure Setting	54
4.5.2	White Balance Setting.....	54
4.5.3	Brightness Setting	55
4.5.4	Sharpness Setting	55
4.5.5	Contrast Setting.....	55
4.5.6	Saturation	56
4.5.7	Hue	56
4.5.8	TV System Setup.....	56
4.6	Logout	56
Appendix A: IP Camera Specifications		57
Appendix B: Internet Security Settings		59
Appendix C: DC Viewer Download Procedure		62
Appendix D: Frequently Asked Questions.....		64

Chapter 1

Introduction



Overview

PLANET announces new H.264 Full-HD IP camera, ICA-HM126, ICA-HM126R, ICA-HM131 and ICA-HM131R to feedback the requirements from worldwide market. The IP Camera support Full HD recording for high quality images. Integrated with the next generation video compression technology – H.264, the IP Camera can compress the video size to smaller one for users to transfer the Full-HD images on Internet easily and fastly.

The IP Camera features Multi-Profile to provide video stream simultaneously. They can deliver clear image with dual H.264/M-JPEG stream video up to 1080p (1920 x 1080 pixels). The IP Cameras use progressive scan to perform full resolution images of moving objects without distortion, in 30 frames per second, which is perfect for critical areas surveillance such as at entrances or exits of the building where are needed to be monitored in greater details. The IP Cameras is compatible with IEEE 802.3af PoE (Power over Ethernet) for easy installation without concerning the outlet / socket locations. Network and analog video output interfaces are equipped for flexible viewing and recording implementations.

PLANET ICA-HM126/126R supports 2-Way audio that can directly make audio communication between local and remote sites by using the external microphone and speaker. Users can build a more advanced security system by connecting external sensors or alarm to DI / DO ports of the ICA-HM126/126R.

The IP Camera can be managed by PLANET Cam Viewer 3 Lite / Pro, the professional central management software for multi-camera video surveillance application, to provide monitoring, recording and event management functions. The Cam Viewer 3 Lite / Pro enables you to setup a comprehensive and effective surveillance system quickly and easily. With the IP Camera managed by the Cam Viewer 3 Lite / Pro, it provides an enhanced professional security environment to protect your property and life.

Product Features

- 1/2.7" progressive CMOS
- Dual video stream : H.264 and M-JPEG video compression simultaneously
- Supports 1080p Full-HD resolution (1920 x 1080 pixels)
- 30 fps at 1080p Video Resolution (ICA-HM126R / ICA-HM131R)
- Compliant with IEEE 802.3af PoE interface
- 3GPP for 3G mobile remote applications
- 2-Way audio function with the external microphone and speaker (ICA-HM126 Series)

- Supports Micro SD card storage
- External I/O trigger for various surveillance applications (ICA-HM126 Series)
- Provides 10 Motion Detection areas can monitor any suspicious movement in specific areas
- Easy configuration and management via Windows-Based utility or web interface
- DDNS, PPPoE and FTP uploading supports more alternatives in surveillance network
- Motion Detection feature can monitor any suspicious movement in specific area
- Cam Viewer 3 - Central management software supported

Package Content

The contents of your product should contain the following items:

- IP Camera
- Lens (ICA-HM126 Series)
- Quick installation guide
- User's manual CD
- Accessories Kit
- Power Adapter (ICA-HM126 Series)

Physical Details

Top View – ICA-HM126 Series

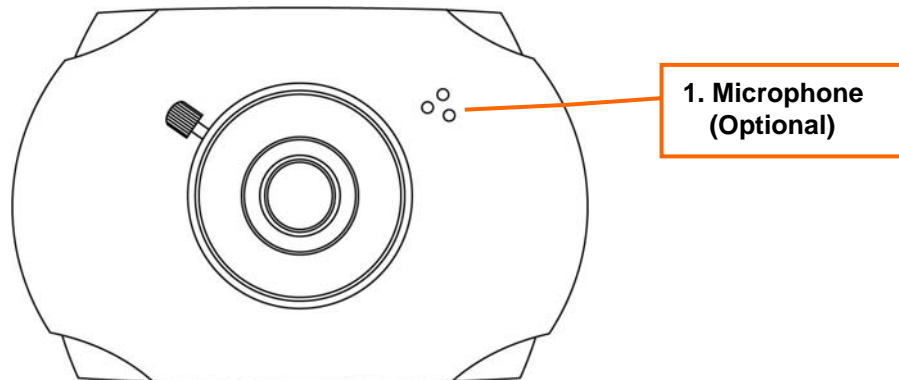

Front View of ICA-HM126/126R

Item		Description
1	Microphone	The internal microphone is optional. This microphone is hidden in the pinhole located on the front panel.

Rear View – ICA-HM126 Series

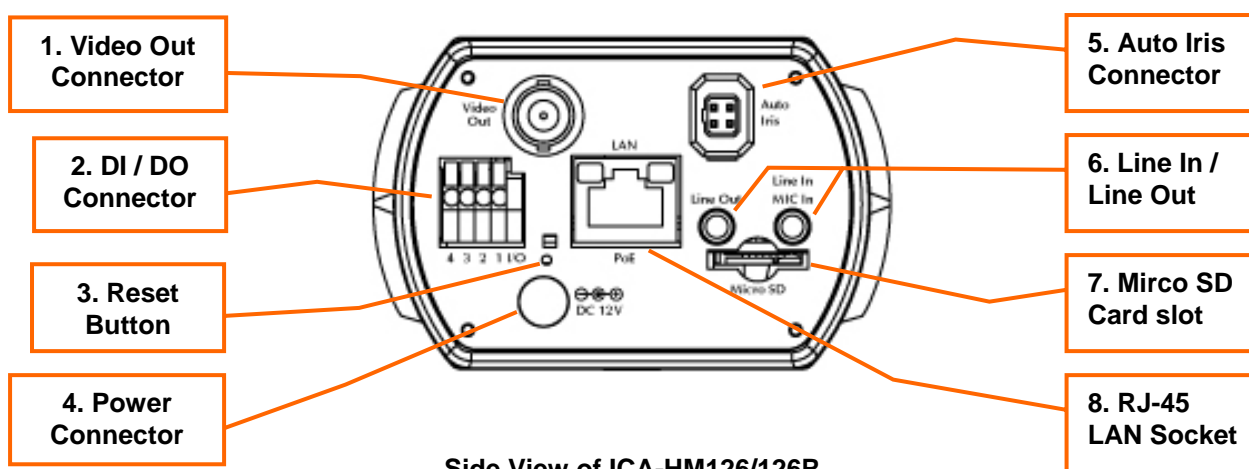

Side View of ICA-HM126/126R

Item		Description										
1	Video Out Connector	The internet camera also provides composite video output. User can use BNC video cable to connect the internet camera with a TV monitor or VCR.										
2	DI / DO Connector	Connect connects to external sensor in and alarm out devices. <table border="1" data-bbox="609 1115 1133 1310"> <thead> <tr> <th>Pin</th> <th>Function</th> </tr> </thead> <tbody> <tr> <td>1</td> <td>Output +</td> </tr> <tr> <td>2</td> <td>Output -</td> </tr> <tr> <td>3</td> <td>Input +</td> </tr> <tr> <td>4</td> <td>Input -</td> </tr> </tbody> </table>	Pin	Function	1	Output +	2	Output -	3	Input +	4	Input -
Pin	Function											
1	Output +											
2	Output -											
3	Input +											
4	Input -											
3	Reset Button	Restore to default setting, press the button with a proper tool.										
4	Power Connector	The input power is 12V DC. Note: ONLY use package power adapter supplied with the product. Otherwise, the product may be damaged.										
5	Auto Iris Connector	The connector can drive CCTV auto iris lenses.										
6	Line In / Line Out											
7	Micro SD Card slot	For video and snapshots storage										
8	RJ-45 LAN Socket	The LAN socket is a RJ-45 connector for connections to 10/100Base-TX Fast Ethernet cabling. The LAN socket is compliant with IEEE802.3af standard PoE interface, and IP Camera is necessary supplied power through PoE Switch/Hub device.										

Top View – ICA-HM131 Series

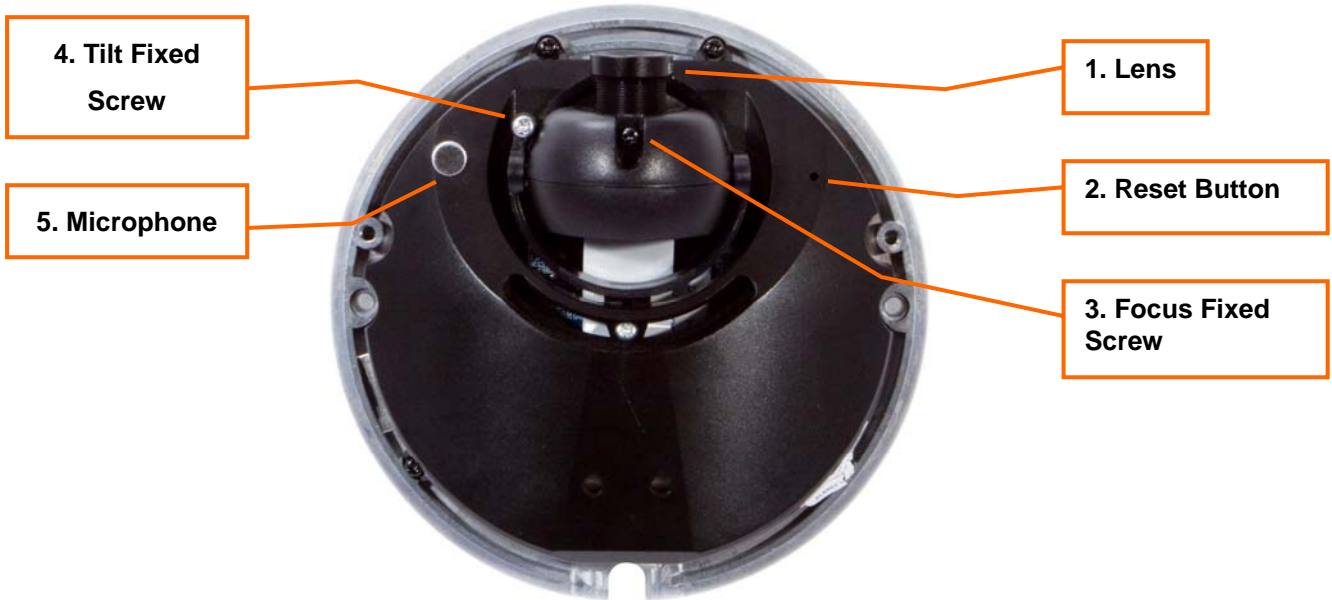
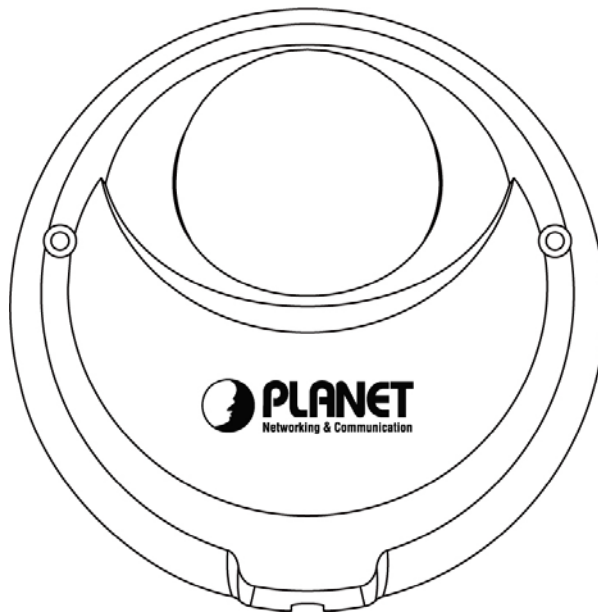

Top View of ICA-HM131/131R

Item		Description
1	Lens	Rotate the lens right/left to adjust focus
2	Reset Button	Restore to default setting, press the button with a proper tool
3	Focus Fixed Screw	Loosen the screw to adjust the lens
4	Tilt Fixed Screw	Loosen the screw to adjust tilt angle
5	Microphone	The IP Camera has built-in an internal microphone. This microphone is hidden in the internal case.

Side View – ICA-HM131 Series



Side View of ICA-HM131/131R

Item		Description
1	Micro-SD Card slot	User can insert a micro SD card into this slot for event recording.
2	RJ-45 LAN Socket	The LAN socket is a RJ-45 connector for connections to 10/100Base-TX Fast Ethernet cabling. The LAN socket is compliant with IEEE802.3af standard PoE interface, and IP Camera is necessary supplied power through PoE Switch/Hub device.

Preparations for IP Camera Setup

Physical Installation Requirement

The notices and introduction on system installation will be described particularly in this chapter. Please follow the description to operate the unit.

In order to prevent the unit from data loss and system damage that caused by a sudden power fluctuation, use of an Uninterruptible Power Supply (UPS) is highly recommended.

2.1 System Requirements

To perform the IP Camera via web browser, please ensure your PC is in good network connection, and meet system requirements as described below for appropriate setup and well view quality.

Items	System Requirement
Personal Computer	1. Intel® Pentium® M, 2.16 GHz or Intel® Core™2 Duo, 2.0 GHz 2. 2 GB RAM or more
Operating System	Windows Vista or Windows XP
Web Browser	Microsoft Internet Explorer 6.0 or later
Network Card	10Base-T (10 Mbps) or 100Base-TX (100 Mbps) operation
Viewer	ActiveX control plug-in for Microsoft IE

2.2 Installation

Please follow the instructions below to complete IP Camera installation.

2.2.1 ICA-HM126 Series Installation

Step 1. Lens Mounting: C/CS Mount Lens Model

If use CS-Mount lens, after removing the camera's plastic cover, users need to mount the C/CS mount adapter to the camera. Then attach the lens onto the C/CS mount adapter, as the illustrations shown below.

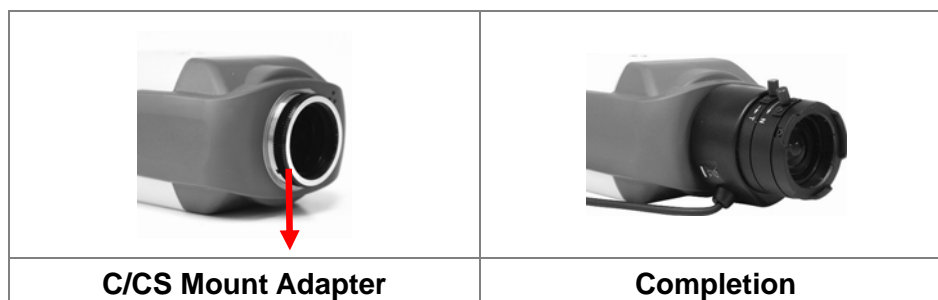



NOTE: The C/CS Mount Adapter isn't attached in product package.

Step 2. Plug an Ethernet cable into the Camera

Connect an Ethernet cable to the LAN socket located on the IP Camera's bottom and attach it to the network.

Step 3. Connect the external power supply to Camera

Connect the attached power adapter to the DC power jack of the IP Camera. Note: Use the power adapter, 12VDC, included in the package and connect it to wall outlet for AC power.

Once you have installed the IP Camera well and powered it on, the network accessing type LED will turn on. It means the system is booting up successfully. Check the status of the link indicator and activity indicator LEDs; if the LEDs are unlit, please check the connections.

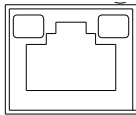

Green Link Light indicates good network connection.

Orange Activity Light flashes for network activity indication.



Note

1. Only use the power adapter supplied with Internet Camera Otherwise, the product may be damaged.
2. The power adapter is unnecessary when Internet Camera is connected to an IEEE802.3af PoE switch. Otherwise, the product may be damaged when Internet Camera is connected to a PoE switch and power adapter simultaneously.

2.2.2 ICA-HM131 Series Installation

Connect the one end of the Ethernet cable to the network port on the camera, and the other end to Power Sourcing Equipment (PSE) like 802.3af POE Hub/ Injector or 802.3af POE Switch.

Check the status of the link indicator and activity indicator LEDs; if the LEDs are unlit, please check the connections.

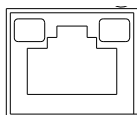

Green Link Light indicates good network connection.

Orange Activity Light flashes for network activity indication.



3. The RJ-45 interface only accept IEEE802.3af PSE (Power Source Equipmetns) Any non-standard or passive POE is not allowed to power the system and will damage the IP Camera permanently.

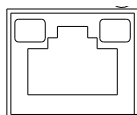

Note

4. You can also consult your local dealer for 802.3af POE PSE devices such as single port injector for single point installation. Or, for mass installation, a Injector Hub for the network that already existed with Ethernet Switches or POE Switch all can be deployed

2.3 Alarm Application (ICA-HM126 Series)

The camera equips one relayalarm input and one relay output for alarm application. Refer to alarm pin definition below to connect alarm devices to the IP Camera if needed.

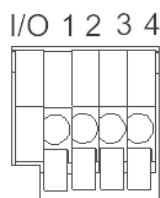

1. Output+
2. Output-
3. Input+
4. Input-

Chapter 3

Accessing Camera

3

For initial access to the IP Camera, users can search the camera through the installer program: DeviceSearch.exe, which can be found in “DeviceSearch” folder in the supplied CD.

3.1 Device Search Software Setup

Step 1: Double click on the program **Planet Device Search.exe** (see the icon below); its window will appear as shown below. Then click the “Device Search” button.

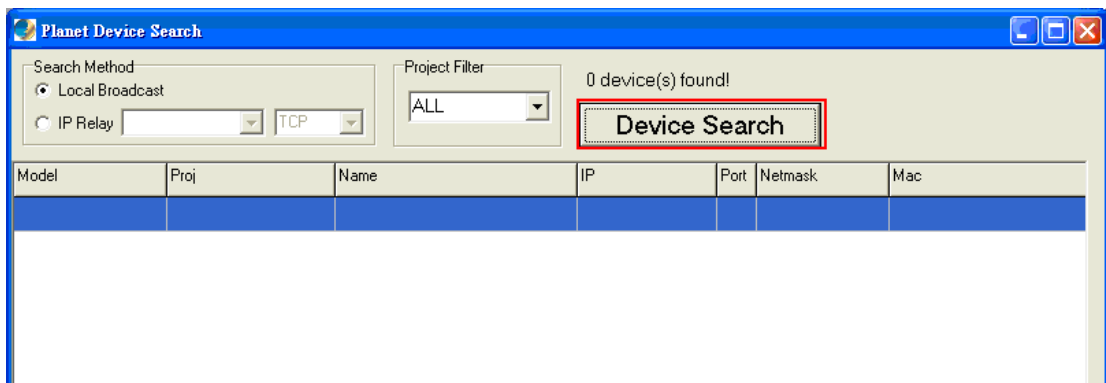

Step 2: The security alert window will pop up. Click “Run” to continue.



3.2 Device Search

Step 3: Click “Device Search” again, and all the finding IP devices will be listed in the page, as shown in the figure below. The IP Camera’s default IP address is: **192.168.0.20**.

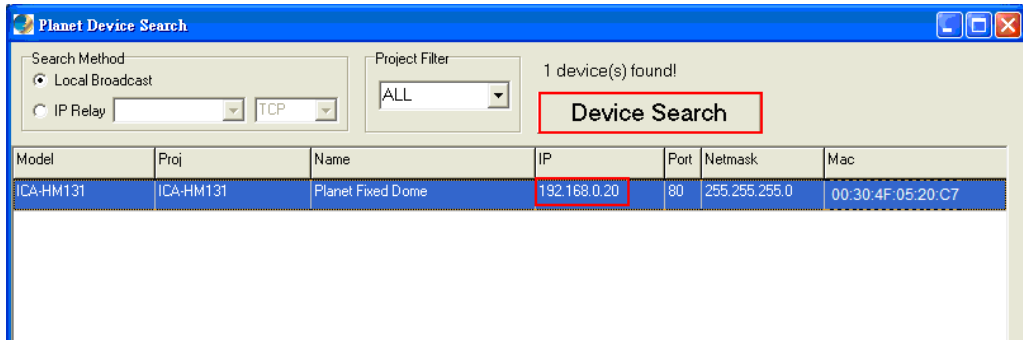

Step 4: Double click or right click and select “Browse” to access the camera directly via web browser.

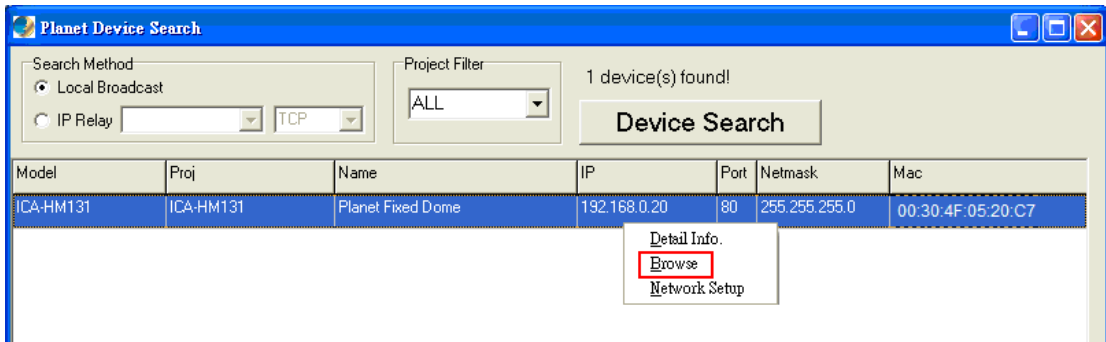

Step 5: Then the prompt window of request for entering default username and password (as shown below) will appear for logging in to the IP Camera.



The default login ID and password for the Administrator are:

Login ID	Password
admin	null (without password)



NOTE: ID and password are case sensitive.



NOTE: It is strongly advised that administrator's password be altered for the security concerns. Refer to section [4.3.2 Security](#) for further details.

Additionally, users can change the IP Camera's network property, either DHCP or Static IP, directly in the device finding list. Refer to the following section for changing the IP Camera's network property.

3.3 Example of Changing IP Camera's Network Property

Users can directly change an IP Camera's network property, ex. from static IP to DHCP, in the finding device list. The way to change the IP Camera's network property is specified below:

Step 1: In the finding device list, click on the IP Camera that you would like to change its network property. On the selected item, right click and select "Network Setup." Meanwhile, record the IP Camera's MAC address, for future identification.

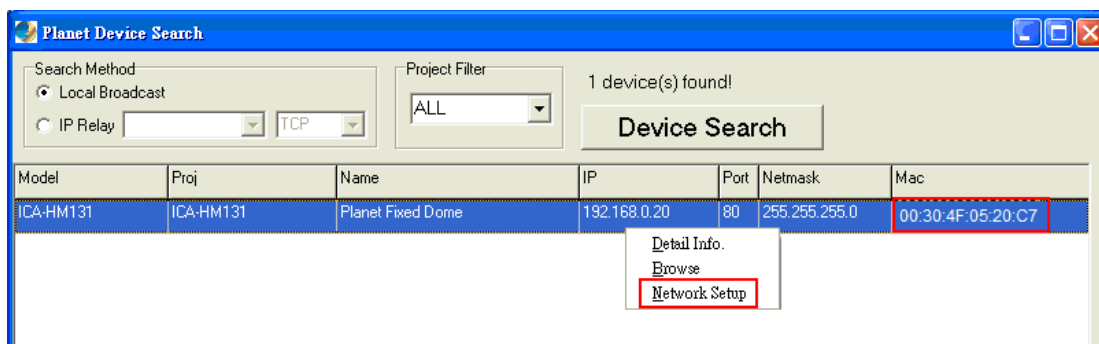

Step 2: The "Network Setup" page will come out. Select "DHCP," and press "Apply" button down the page.

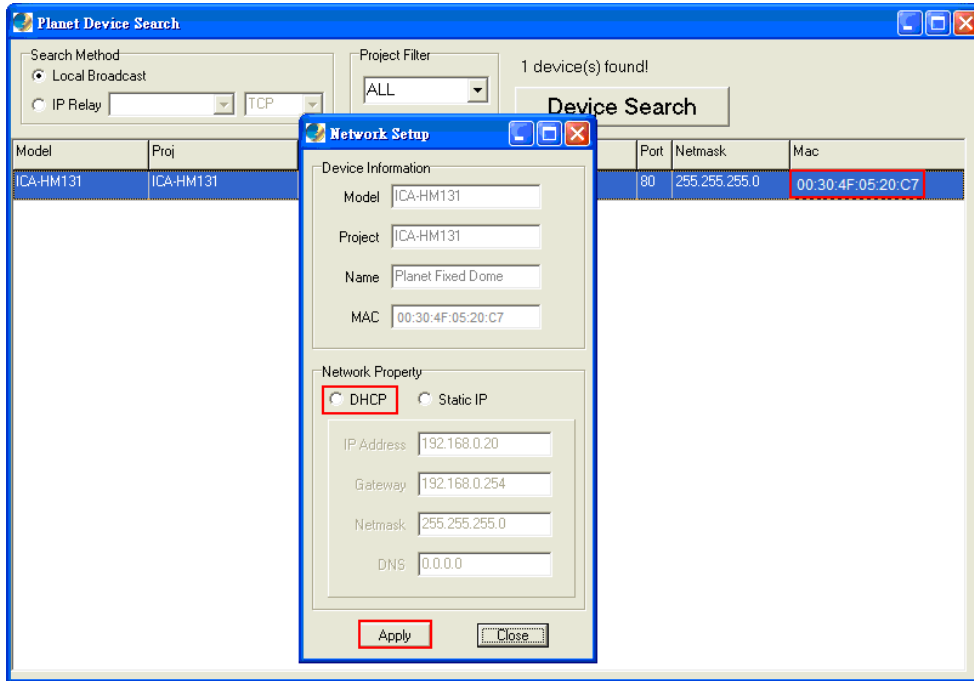

Step 3: Click “OK” on the Note of setting change. Wait for one minute to re-search the IP Camera.

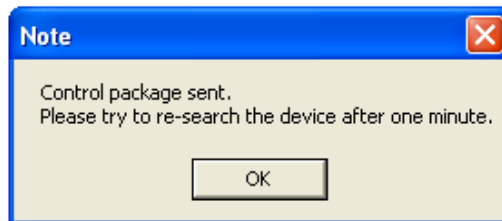

Step 4: Click the “Device Search” button to search all the devices. Then select the IP Camera with the correct MAC address. Double click on the IP Camera, and the login window will come out.

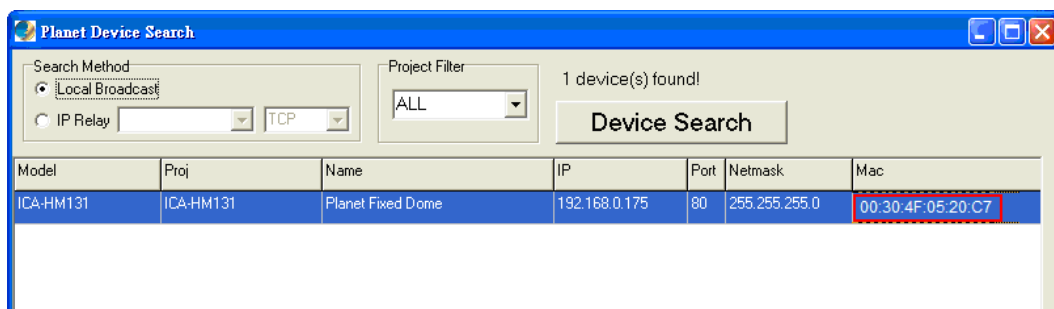

Step 5: Enter User name and Password to access the IP Camera.

3.4 Installing DC Viewer Software Online

For the initial access to the IP Camera, a client program, DC Viewer, will be automatically installed to your PC when connecting to the IP Camera.

If the Web browser doesn't allow DC Viewer installation, please check the Internet security settings or

ActiveX controls and plug-ins settings (see [Appendix B: Internet Security Settings](#)) to continue the process.

The Information Bar (just below the URL bar) may come out and ask for permission to install the ActiveX Control for displaying video in browser (see the figure below). Right click on the Information Bar and select “Install ActiveX Control...” to allow the installation.

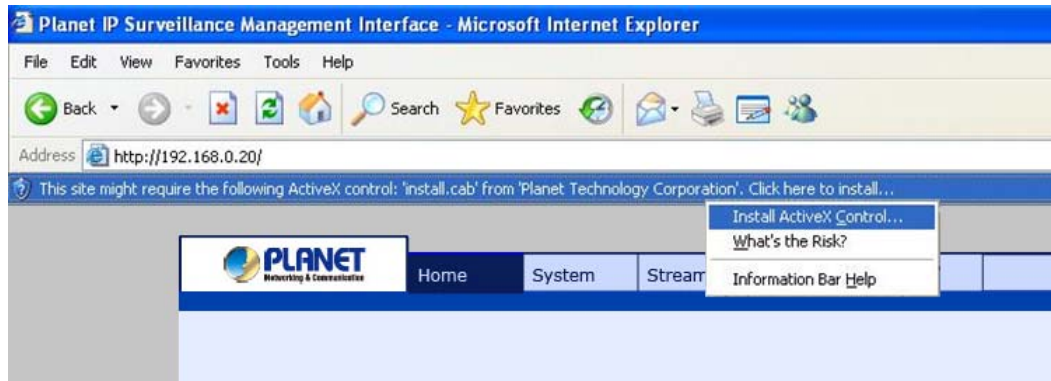

Then the security warning window will pop up. Click “Install” to carry on software installation.

Click “Finish” to close the DC Viewer window when download is finished.

Once login to the IP Camera, users will see the Home page as shown below:



NOTE: The “talk” button below the screen only displays in ICA-HM126 Series IP Camera.

3.5 Administrator / User Privileges

“Administrator” represents the person who can configure the IP Camera and authorize user’s access to the camera; “User” refers to whoever has access to the camera with limited authority, i.e. entering Home and Camera setting pages.

3.6 Lens Adjustment

The image displays on the Home page when successfully accessing to the IP Camera. Adjust the camera’s focus to produce a clear image. Please refer to the procedure below.

ICA-HM131 Series Lens Adjustment

Step 1: Unscrew the IP Camera’s cover.



Step 2: Loosen the focus fixed screw, and rotate the lens counter-/clockwise to adjust focus; loosen the tilt fixed screw, and adjust the camera’s tilt angle.

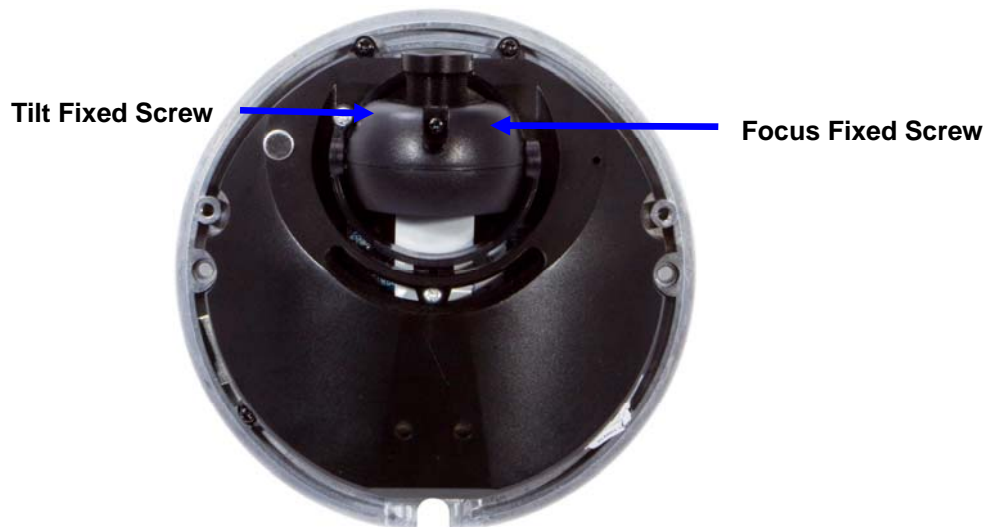

Configuration & Operation

The IP Camera is provided with a user-friendly browser-based configuration interface, and a free bundled CMS (Central Management System) for record and playback video. In this chapter, information about main page introduction, system related settings and camera settings will be described in detail.

4.1 Browser-based Viewer Introduction

The figure below shows the Home page of the IP Camera's Viewer Window.

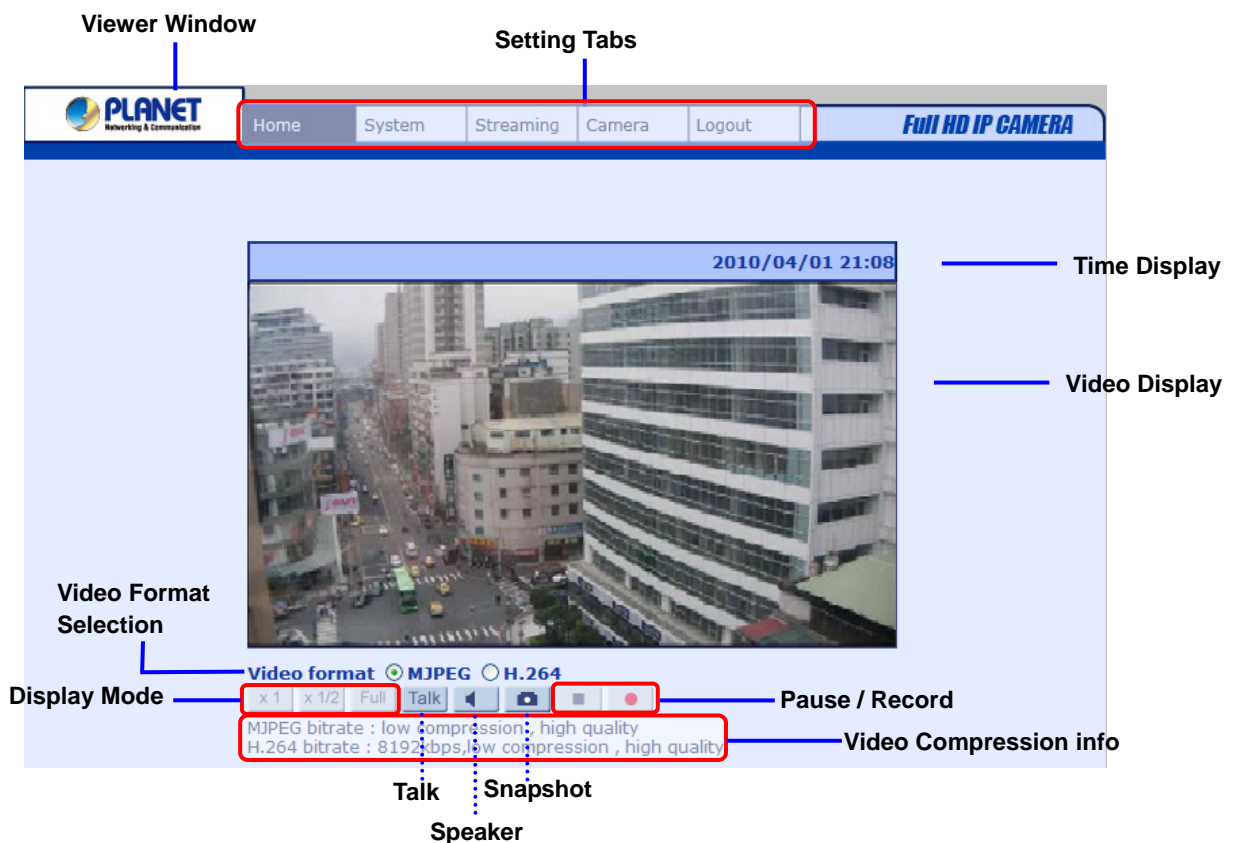

There are five tabs: Home, System, Streaming, Camera and Logout on the top of the viewer window.

Home

Users can monitor live video of the targeted area.

System setting

The administrator can set host name, system time, root password, network related settings, etc. Further details will be interpreted in section [4.3 System Related Settings](#).

Streaming setting

The administrator can modify video resolution and rotate type and select audio compression mode in this page.

Camera setting

Users can adjust various camera parameters, including <Exposure>, <White Balance>, <Brightness>, <Sharpness>, <Contrast> and <Digital Zoom>.

Logout

Click on the tab to re-login the IP Camera with another username and password.

4.2 Home Page

In the Home page, there are several function buttons right down the displayed image.



Screen Size Adjustment

Image display size can be adjusted to x1/2 and full screen.

Digital Zoom Control

In the full screen mode, users can implement digital zoom by right clicking the mouse, rotating the mouse wheel (for zoom in/out) and dragging the mouse into any direction.

Talk

Talk function allows the local site talks to the remote site. This function is only open to "User" who has been granted this privilege by the Administrator.



NOTE: This function is only available for ICA-HM126 Series IP Camera.

Speaker

This button is used to mute or activate the audio. This function is only open to “User” who has been granted this privilege by the Administrator.

Snapshot

Press the  button, and the JPEG snapshots will automatically be saved in the appointed place. The default place of saving snapshots is: C:\.

Video Pause

Press this button to pause or restart the video streaming.

Recording

Saving video recordings from the Live View to the specified location

4.3 System Related Settings

The figure below shows all categories under the “**System**” tab. Each category in the left column will be explained in the following sections.



NOTE: The “System” configuration page is only accessible by the Administrator.

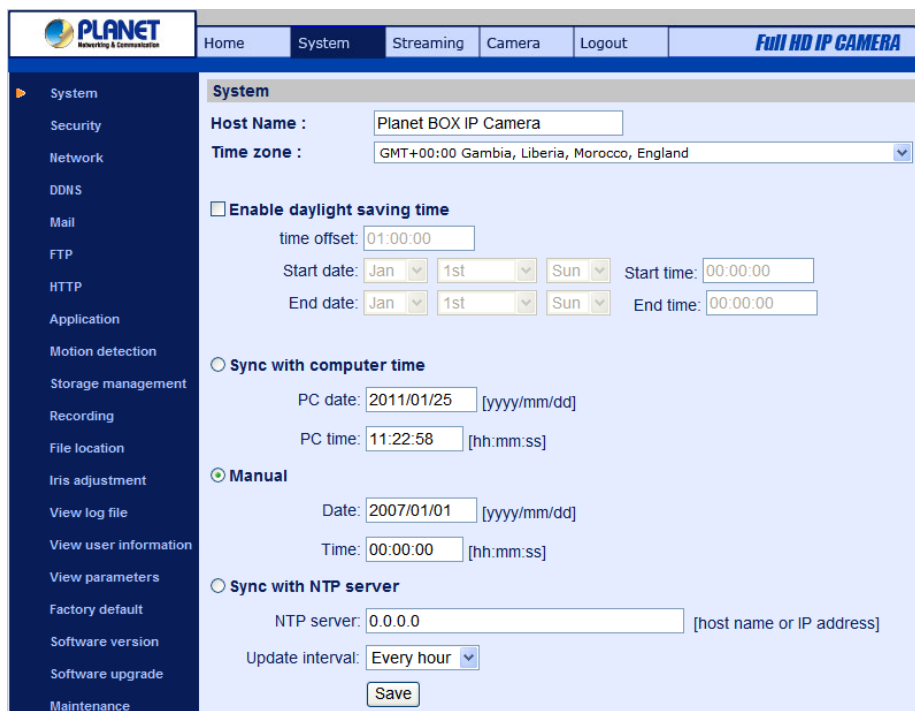

The screenshot displays the 'System' configuration page of a Planet IP camera. The interface includes a top navigation bar with 'Home', 'System', 'Streaming', 'Camera', and 'Logout' tabs, and a 'Full HD IP CAMERA' label. A left sidebar lists various system settings categories. The main configuration area is titled 'System' and contains the following fields and options:

- Host Name :** Planet BOX IP Camera
- Time zone :** GMT+00:00 Gambia, Liberia, Morocco, England
- Enable daylight saving time**
 - time offset: 01:00:00
 - Start date: Jan 1st Sun Start time: 00:00:00
 - End date: Jan 1st Sun End time: 00:00:00
- Sync with computer time**
 - PC date: 2011/01/25 [yyyy/mm/dd]
 - PC time: 11:22:58 [hh:mm:ss]
- Manual**
 - Date: 2007/01/01 [yyyy/mm/dd]
 - Time: 00:00:00 [hh:mm:ss]
- Sync with NTP server**
 - NTP server: 0.0.0.0 [host name or IP address]
 - Update interval: Every hour
 - Save button

4.3.1 Host Name and System Time Setting

Press the first category: <System> in the left column; the page is shown as below.

The screenshot displays the 'System' configuration page of a Planet IP camera. The interface includes a top navigation bar with 'Home', 'System', 'Streaming', 'Camera', and 'Logout' tabs, and a 'Full HD IP CAMERA' label. A left sidebar lists various system settings, with 'System' selected. The main configuration area contains the following fields and options:

- Host Name :** Planet BOX IP Camera
- Time zone :** GMT+00:00 Gambia, Liberia, Morocco, England
- Enable daylight saving time**
 - time offset: 01:00:00
 - Start date: Jan 1st Sun Start time: 00:00:00
 - End date: Jan 1st Sun End time: 00:00:00
- Sync with computer time**
 - PC date: 2011/01/25 [yyyy/mm/dd]
 - PC time: 11:22:58 [hh:mm:ss]
- Manual**
 - Date: 2007/01/01 [yyyy/mm/dd]
 - Time: 00:00:00 [hh:mm:ss]
- Sync with NTP server**
 - NTP server: 0.0.0.0 [host name or IP address]
 - Update interval: Every hour

A 'Save' button is located at the bottom of the configuration area.

Host Name

The name is for camera identification. If Motion Detection function is enabled and is set to send alarm message by Mail/FTP, the host name entered here will display in the alarm message.

Time Zone

Select the time zone you are in from the drop-down menu.

Enable daylight saving time

Select this item to enable daylight saving adjustment. Setting up the date and time of daylight saving start and end time.

Sync with Computer Time

Select the item, and video date and time display will synchronize with the PC's.

Manual

The Administrator can set video date, time and day manually. Entry format should be identical with that shown next to the enter fields.

Sync with NTP server

Network Time Protocol (NTP) is an alternate way to synchronize your camera's clock with a NTP server. Please specify the server you wish to synchronize in the enter field. Then select an update interval from the drop-down menu. For further information about NTP, please see the web site: www.ntp.org.

4.3.2 Security

Click the category: <Security>, and the page is shown as the figure below.

The screenshot shows the PLANET Fuji HD IP CAMERA web interface. The top navigation bar includes 'Home', 'System', 'Streaming', 'Camera', and 'Logout'. The left sidebar menu has 'Security' highlighted with a red box. The main content area is titled 'Security' and contains three sections: 'admin Password' with two password input fields and a 'Save' button; 'Add User' with 'User name' and 'User password' input fields, checkboxes for 'I/O access', 'Camera control', 'Talk', and 'Listen', and an 'Add' button; and 'Manage User' with a 'User name' dropdown menu and 'Delete' and 'Edit' buttons.

Root password

Change the administrator's password by inputting the new password in both text boxes. The input characters/numbers will be displayed as dots for security purposes. After clicking <Save>, the web browser will ask the Administrator for the new password for access. The maximum length of the password is 14 digits.



NOTE: The following characters are valid: A-Z, a-z, 0-9, !#\$%&'-.@^_~.

Add user

Type the new user's name and password and click <Add> to add the new user. Both user name and password can be up to 16 characters. The new user will be displayed in the user name list. There is a maximum of twenty user accounts. Each user can be assigned the privileges of “**Camera control**” and/or “**Listen**”.

- **I/O access**

This item supports fundamental functions that enable users to view video when accessing to the camera.

- **Camera control**

This item allows the appointed User to change camera parameters on the Camera Setting page.

- **Talk / Listen**

Talk and Listen functions allow the appointed user in the local site (PC site) communicating with, for instance, the administrator in the remote site.



NOTE: The ICA-HM131 Series do not have the Talk function.

Manage User

Delete user

To delete a user, pull down the user list, and select the user name you wish to delete. Then click <Delete> to remove it.

Edit user

Pull down the user list and select a user name. Click <Edit> to edit the user's password and privilege.



NOTE: It is required to enter the User password as well as select the function open to the user. When finished, click <Save> to modify the account authority.

http://192.168.7.234/lang1/server_editaccount.html - Micr...

User name [User]
User password [.....]

I/O access Camera control
 Talk Listen

Save Close

4.3.3 Network

Click <Network> in the left column, and the page will display as shown below.

Users can choose to use fixed IP address or dynamic (DHCP) IP address. The following is descriptions for the two ways of setting IP address.

Get IP address automatically (DHCP)

The camera's default setting is "Use fixed IP address". Please refer to the previous section [Chapter 3. Accessing Camera](#) for logging in with the default IP address.

If select "Get IP address automatically", after the IP Camera restarts, users can search it through the installer program: DeviceSearch.exe, which can be found in "DeviceSearch" folder in the supplied CD.



NOTE: Please make the record of the IP Camera's MAC address, which can be found in the label of the camera, for identification in the future.

Use fixed IP address

To setup static IP address, select "Use fixed IP address" and move the cursor to the IP address blank

(as indicated below) and insert the new IP address, ex. 192.168.0.250; then go to the Default gateway (explained latter) blank and change the setting, ex. 192.168.0.250. Press “Save” to confirm the new setting.

The screenshot shows the PLANET Full HD IP CAMERA web interface. The top navigation bar includes 'Home', 'System', 'Streaming', 'Camera', and 'Logout'. The left sidebar lists various system settings: System, Security, Network (selected), DDNS, Mail, FTP, HTTP, Application, Motion detection, Storage management, Recording, and File location. The main content area is titled 'Network' and 'General'. It offers two options for IP addressing: 'Get IP address automatically' (unselected) and 'Use fixed IP address' (selected). The 'Use fixed IP address' section contains several input fields: 'IP address' (192.168.0.20), 'Subnet mask' (255.255.255.0), 'Default gateway' (192.168.0.254), 'Primary DNS' (0.0.0.0), and 'Secondary DNS' (0.0.0.0). Below these is a 'Use PPPoE' section with 'User name' and 'Password' fields. A 'Save' button is located at the bottom right of the configuration area.

When using static IP address to login to the IP Camera, users can access it either through “DeviceSearch” software (see [Chapter 3. Accessing Camera](#)) or input the IP address in the URL bar and press “Enter”.

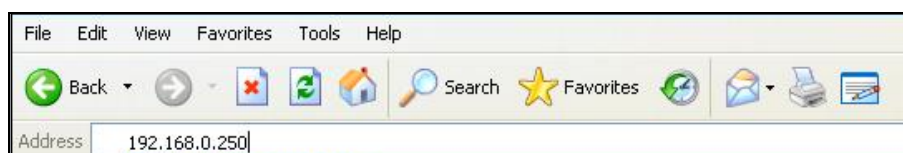

General

- **IP address**

This is necessary for network identification.

- **Subnet mask**

It is used to determine if the destination is in the same subnet. The default value is “255.255.255.0”.

- **Default gateway**

This is the gateway used to forward frames to destinations in different subnet. Invalid gateway setting will fail the transmission to destinations in different subnet.

- **Primary DNS**

Primary DNS is the primary domain name server that translates hostnames into IP addresses.

- **Secondary DNS**

Secondary DNS is a secondary domain name server that backups the primary DNS.

Use PPPoE

To select the PPPoE service here. Type the user name and password for the PPPoE service which is provided by ISP.

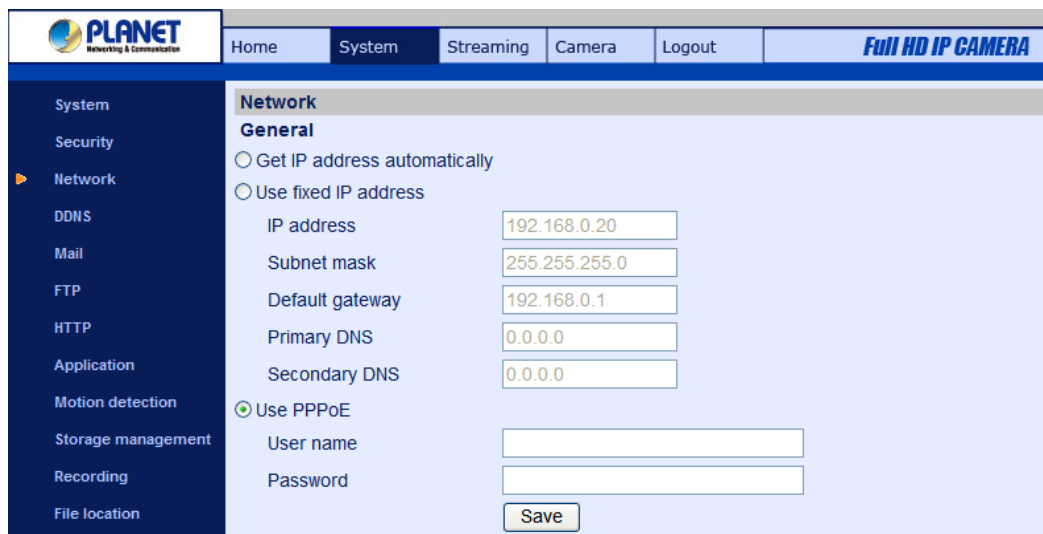

The screenshot shows the PLANET Full HD IP CAMERA web interface. The top navigation bar includes 'Home', 'System', 'Streaming', 'Camera', and 'Logout'. The left sidebar lists various system settings: System, Security, Network (selected), DDNS, Mail, FTP, HTTP, Application, Motion detection, Storage management, Recording, and File location. The main content area is titled 'Network' and 'General'. It offers two options: 'Get IP address automatically' (unselected) and 'Use fixed IP address' (unselected). Below these are input fields for IP address (192.168.0.20), Subnet mask (255.255.255.0), Default gateway (192.168.0.1), Primary DNS (0.0.0.0), and Secondary DNS (0.0.0.0). The 'Use PPPoE' option is selected with a radio button. Below it are input fields for 'User name' and 'Password', and a 'Save' button.

Advanced

- **Web Server port**

The default web server port is 80. Once the port is changed, the user must be notified the change for the connection to be successful. For instance, when the Administrator changes the HTTP port of the IP Camera whose IP address is 192.168.0.100 from 80 to 8080, the user must type in the web browser "http://192.168.0.100:8080" instead of "http://192.168.0.100".

- **RTSP port**

RTSP port could be set from 1 to 65535. (Normal Setting Port: 554, 1024 ~65535)

- **MJPEG over HTTP port**

The default setting of HTTP Port is 8008; setting range: 1024 ~65535.



NOTE: Be aware to choose the different port from the one set for the web server port.

4.3.4 DDNS

Dynamic Domain Name System (DDNS) allows a host name to be constantly synchronized with a dynamic IP address. In other words, it allows those using a dynamic IP address to be associated to a static domain name so others can connect to it by name.

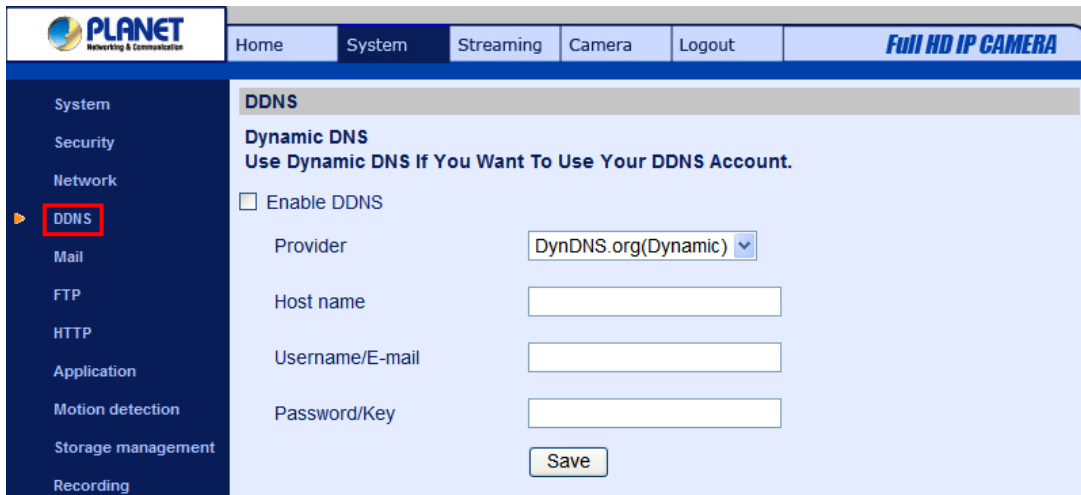

Enable DDNS

Check the item to enable DDNS.

Provider

Select one DDNS host from the provider list.

Host name

Enter the registered domain name in the field.

Username/E-mail

Enter the username or e-mail required by the DDNS provider for authentication.

Password/Key

Enter the password or key required by the DDNS provider for authentication.

4.3.5 Mail

The Administrator can send an e-mail via Simple Mail Transfer Protocol (SMTP) when motion is detected. SMTP is a protocol for sending e-mail messages between servers. SMTP is a relatively simple, text-based protocol, where one or more recipients of a message are specified and the message text is transferred. The configuration page is shown as follows:

PLANET Networking & Communication

Home System Streaming Camera Logout **Fuji HD IP CAMERA**

System
Security
Network
DDNS
▶ **Mail**
FTP
HTTP
Application
Motion detection
Storage management
Recording
File location
Iris adjustment
View log file

Mail

SMTP

1st SMTP (mail) server

1st SMTP (mail) server port

1st SMTP account name

1st SMTP password

1st recipient email address

2nd SMTP (mail) server

2nd SMTP (mail) server port

2nd SMTP account name

2nd SMTP password

2nd recipient email address

Sender email address

Save

Two sets of SMTP can be configured. Each set includes SMTP Server, Account Name, Password and E-mail Address settings. For SMTP server, contact your network service provider for more specific information.

4.3.6 FTP

The Administrator can set as sending alarm message to a specific File Transfer Protocol (FTP) site when motion is detected. Users can assign alarm message to up to two FTP sites. The FTP setting page is shown below. Enter the FTP details, which include server, server port, user name, password and remote folder, in the fields. Press “Save” when finished.

PLANET Networking & Communication

Home System Streaming Camera Logout **Fuji HD IP CAMERA**

System
Security
Network
DDNS
Mail
▶ **FTP**
HTTP
Application
Motion detection
Storage management
Recording
File location
Iris adjustment
View log file
View user information

FTP

FTP

Built-in FTP server port

1st FTP server

1st FTP server port

1st FTP user name

1st FTP password

1st FTP remote folder

1st FTP passive mode

2nd FTP server

2nd FTP server port

2nd FTP user name

2nd FTP password

2nd FTP remote folder

2nd FTP passive mode

Save

4.3.7 HTTP Notification

The HTTP Notification server can listen for notification messages from IP Cameras by triggered events. Alarm triggered and Motion Detection notifications can be sent to the specified HTTP server.

The screenshot shows the Planet IP Camera web interface. The top navigation bar includes 'Home', 'System', 'Streaming', 'Camera', and 'Logout'. The left sidebar lists various system settings, with 'HTTP' highlighted in red. The main content area is titled 'HTTP' and contains the following configuration fields:

- 1st HTTP server:
- 1st HTTP user name:
- 1st HTTP password:
- 2nd HTTP server:
- 2nd HTTP user name:
- 2nd HTTP password:

A 'Save' button is located at the bottom right of the configuration area.

4.3.8 Application (ICA-HM126 Series)

The ICA-HM126 Series IP Camera equips one alarm input and one relay output for cooperating with alarm system to catch events' images. The alarm configuration page is also shown below.

The screenshot shows the Planet IP Camera web interface. The top navigation bar includes 'Home', 'System', 'Streaming', 'Camera', and 'Logout'. The left sidebar lists various system settings, with 'Application' highlighted in red. The main content area is titled 'Application' and contains the following configuration sections:

- Alarm Switch:** Off On
- Alarm Type:** Normal close Normal open
- Alarm Output:** Output high Output low
- Triggered Action:**
 - Enable alarm output
 - Send message by FTP
 - Upload image by FTP
 - Send HTTP notification
 - Record stream to sd card
 - Send message by E-Mail
 - Upload image by E-Mail
- File Name:**
 - File name:
 - Add date/time suffix
 - Add sequence number suffix (no maximum value)
 - Add sequence number suffix up to and then start over
 - Overwrite

A 'Save' button is located at the bottom of the configuration area.

Alarm Switch

The Administrator can enable or disable the alarm function.

Alarm Type

Select an alarm type, "Normal close" or "Normal open," that corresponds with the alarm application.

Alarm Output

Define alarm output signal “high” or “low” as the normal alarm output status according to the current alarm application.

Action (Multi-option)

The Administrator can specify alarm actions that will take when the alarm is triggered. All options are listed as follows:

- **Enable Alarm Output**

Select the item to enable alarm relay output.

- **Record Stream to SD Card**

When the alarm is triggered, the stream will be uploaded to the SD card.

- Pre-trigger buffer: Start to upload the stream before the alarm is triggered.
- Upload: Upload the stream during the specific time.
- Upload during the trigger active: Upload the stream during the trigger active.

Triggered Action

- Enable alarm output
- Send message by FTP
- Upload image by FTP
- Send HTTP notification
- Record stream to sd card
 - Pre-trigger buffer sec
 - Upload for sec
 - Upload during the trigger active
- Send message by E-Mail
- Upload image by E-Mail

- **Send Message by FTP / E-Mail**

The Administrator can select whether to send an alarm message by FTP or / and E-Mail when an alarm is triggered.

- **Upload Image by FTP**

Select this item, and the Administrator can assign a FTP site and configure various parameters as shown in the figure below. When the alarm is triggered, event images will be uploaded to the appointed FTP site.

Triggered Action

- Enable alarm output
- Send message by FTP
- Upload image by FTP
 - FTP address
 - Pre-trigger buffer frames
 - Post-trigger buffer frames
 - Continue image upload
 - Upload for sec
 - Upload during the trigger active
 - Image frequency fps
- Send HTTP notification
- Record stream to sd card
- Send message by E-Mail
- Upload image by E-Mail

- **Upload Image by E-Mail**

Select this item, and the Administrator can assign an e-mail address and configure various parameters as shown in the figure below. When the alarm is triggered, event images will be sent to the appointed e-mail address.



NOTE: Make sure SMTP or FTP configuration has been completed. See section [4.3.5 Mail](#) and [4.3.6 FTP](#) for further details.

- **Send HTTP notification**

When the alarm be triggered, the notifications can be sent to the specified HTTP server.

- The parameters for the HTTP Notification can be specified, which will show on the URL when events being triggered.

File Name

Enter a file name in the blank, ex. image.jpg. The uploaded image's file name format can be set in this section. Please select the one that meets your requirements.

- **Add date/time suffix**

File name: imageYYMMDD_HHNNSS_XX.jpg

Y: Year, M: Month, D: Day

H: Hour, N: Minute, S: Second

X: Sequence Number

- **Add sequence number suffix (no maximum value)**

File name: imageXXXXXXXXX.jpg

X: Sequence Number

- **Add sequence number suffix (limited value)**

File Name: imageXX.jpg

X: Sequence Number

The file name suffix will end at the number being set. For example, if the setting is up to “10,” the file name will start from 00, end at 10, and then start all over again.

- **Overwrite**

The original image in the FTP site will be overwritten by the new uploaded file with a static filename.

Save

After complete all the settings mentions above, please click on the Save button to save all the settings in this page.

4.3.9 Motion Detection

Motion Detection function allows detecting suspicious motion and triggering alarms when motion volume in the detected area reaches/exceeds the determined sensitivity threshold value.

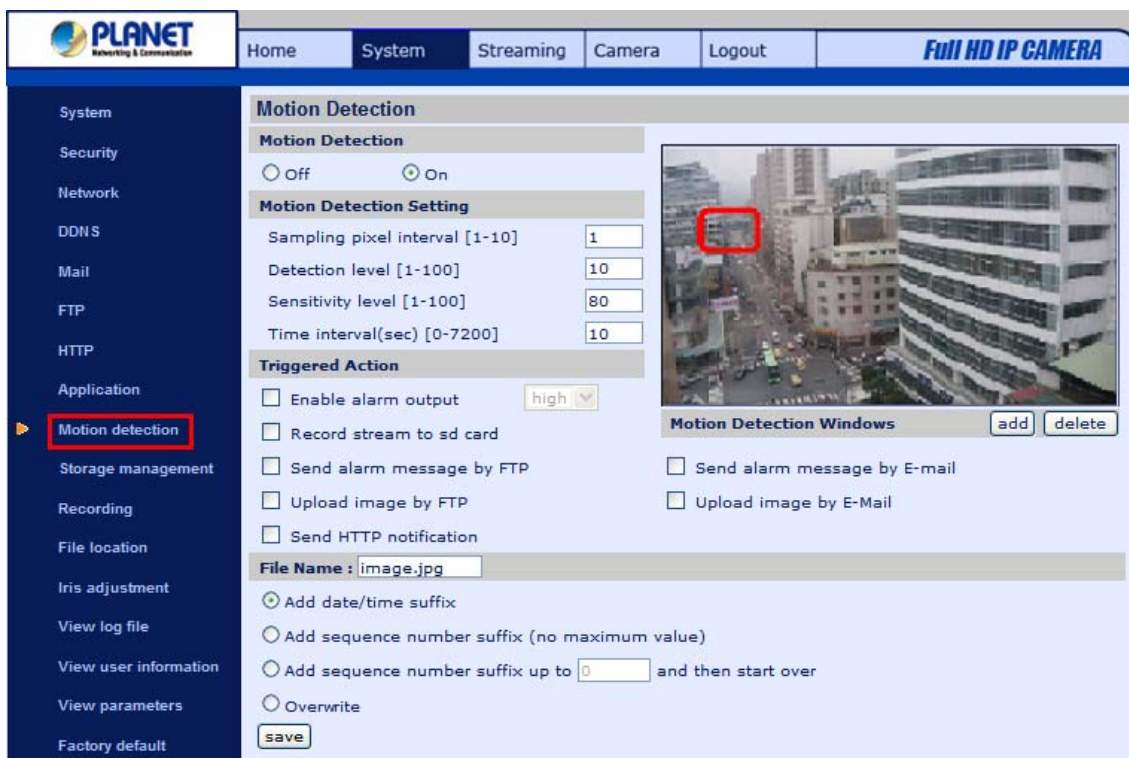

In the Motion Detection setting page, there is a frame (**Motion Detection Window**) displayed on the Live View Pane. The Motion Detection Window is for defining the motion detection area. To change the size of the Motion Detection Window, move the mouse cursor to the edge of the frame and draw it outward/inward. Moving the mouse to the center of the frame can shift the frame to the intended location.

Up **10** Motion Detection Windows can be set. Press the “add” button under the Live View Pane to add a Motion Detection Window. To cancel a Motion Detection Window, move the mouse cursor to the selected Window, and click on the “delete” button.

If Motion Detection function is activated, the pop-off window (Motion) with indication of motion will be shown.

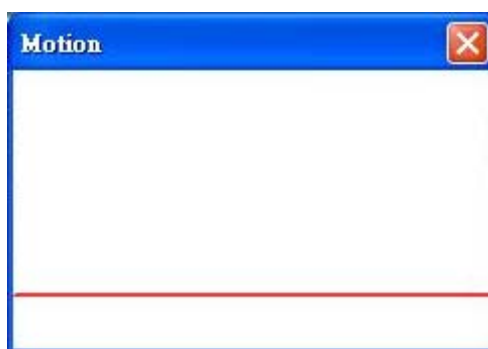

When motion is detected, the signals will be displayed on the Motion window as shown below.

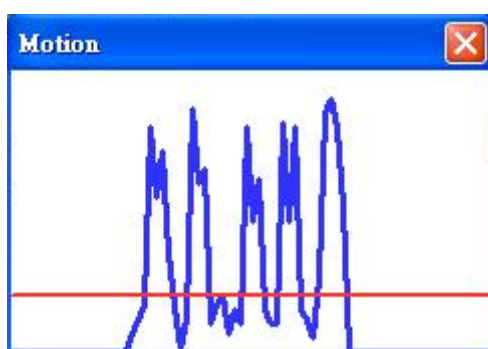

Detailed settings of Motion Detection are described as follows:

Motion Detection

You will be able to turn on/off Motion Detection in System section. Default setting is Off.

Motion Detection Setting

Users could adjust various parameters of Motion Detection in this section.

- Sampling pixel interval [1-100]:

The default value is 10, which means system will take one sampling pixel for every 10 pixel.

- Detection level [1-100]:

The default level is 10. The item is to set detection level for each sampling pixel; the smaller the value, the more sensitive it is.

- Sensitivity level [1-100]:

The default level is 80, which means if 20% or more sampling pixels are detected differently, system will detect motion. The bigger the value, the more sensitive it is. Meanwhile, when the value is bigger, the red horizontal line in the motion indication window will be lower accordingly.

- Time interval (sec) [0-7200]:

The default interval is 10. The value is the interval between each detected motion.

Users could adjust the parameter and level of Motion Detection Settings.

- Sampling pixel interval [1-100]: Default value: 10
- Detection level [1-100]: Default value: 10
- Sensitivity level [1-100]: Default value: 80
- Time interval (sec) [0-7200]: Default value: 10

Total four actions could be selected once the motion is detected.

Triggered Action (Multi-option)

The Administrator can specify alarm actions that will take when motion is detected. All options are listed as follows:

- **Enable Alarm Output**

Check the item and select the predefined type of alarm output to enable alarm relay output when motion is detected.



NOTE: This option is excluded in the IP Camera.

- **Record Stream to SD Card**

When the alarm is triggered, the stream will be uploaded to the SD card.

- Pre-trigger buffer: Start to upload the stream before the alarm is triggered.
- Upload: Upload the stream during the specific time.
- Upload during the trigger active: Upload the stream during the trigger active.

- **Send Alarm Message by FTP/E-Mail**

The Administrator can select whether to send an alarm message by FTP and/or E-Mail when motion is detected.

- **Upload Image by FTP**

Select this item, and the Administrator can assign a FTP site and configure various parameters as shown in the figure below. When motion is detected, event images will be uploaded to the appointed FTP site.

Upload Image by FTP

FTP address FTP1 ▾

Pre-trigger buffer 5 frames ▾

Post-trigger buffer 5 frames ▾

Continue image upload

Upload for sec

Upload during the trigger active

Image frequency Max. ▾ fps

- **Upload Image by E-Mail**

Select this item, and the Administrator can assign an e-mail address and configure various parameters as shown in the figure below. When motion is detected, event images will be sent to the appointed e-mail address.

Upload Image by E-Mail

E-Mail address E-Mail 1 ▾

Pre-trigger buffer 5 frames ▾

Post-trigger buffer 5 frames ▾

Continue image upload

Upload for sec

Upload during the trigger active

Image frequency Max. ▾ fps



NOTE: Make sure SMTP or FTP configuration has been completed. See section [4.3.5 Mail](#) and [4.3.6 FTP](#) for further details.

- **Send HTTP notification**

When the alarm be triggered, the notifications can be sent to the specified HTTP server.

- The parameters for the HTTP Notification can be specified, which will show on the URL when events being triggered.

File Name

The uploaded image's filename format can be set in this section. Please select the one that meets your requirements.

Save

Click the Save button to save all the Motion Detection settings mentioned above.

4.3.10 Storage management

This page shows the status of attached Micro-SD card. You may setup related parameters to manage the attached Micro-SD card also.

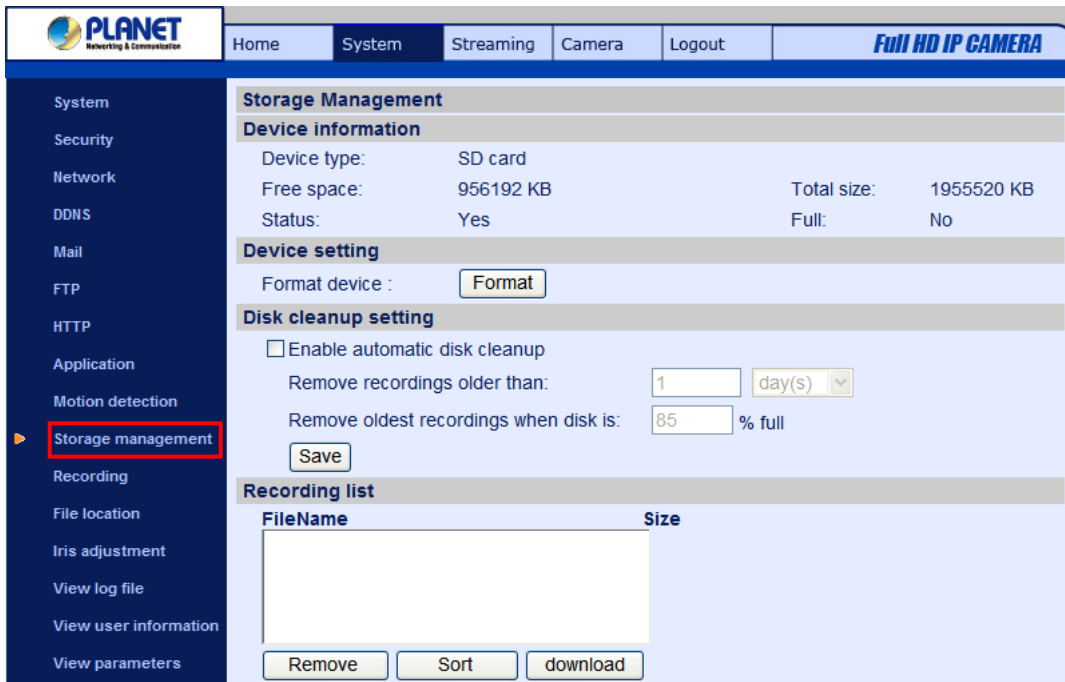

Enable automatic disk cleanup

Delete old recorded files while the conditions are reached as below.

Remove recordings older than

Delete old files by days.

Remove oldest recordings when disk is

Delete old files by left capacity.

4.3.11 Recording

Select “Always” option to save the video whole the time, or select the “Only during time frame” option to save video by specific time. The video file is saved as AVI format into Micro-SD card and your local PC. While you want to stop it, select “Disable” option to stop recording.

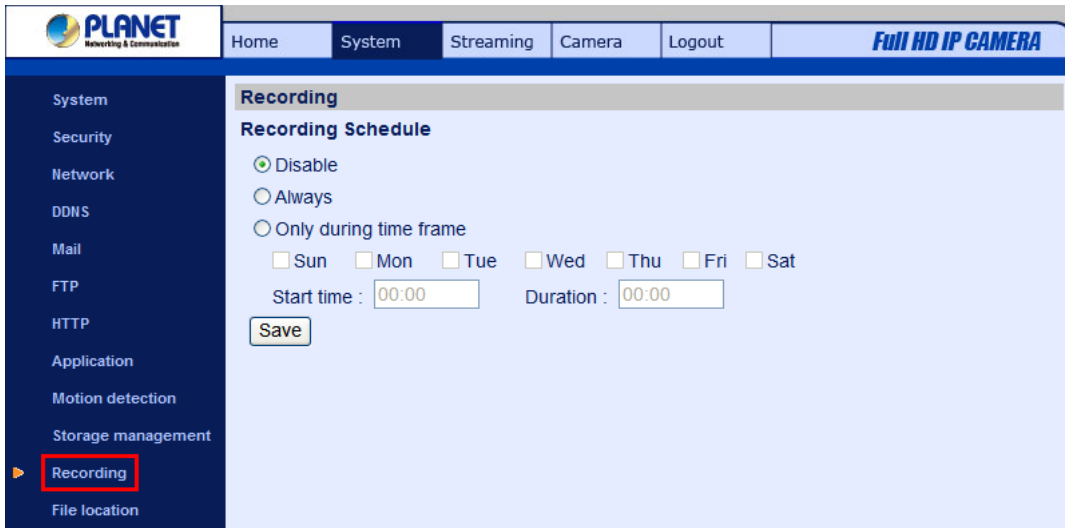

4.3.12 File location

Set the storage location for the snapshot photos and record video files. The default setting is: C:\. Once confirm the setting, press “Save,” and all the images and videos will be saved in the designate location.



NOTE: Make sure the selected file path contains valid characters such as letters and numbers.

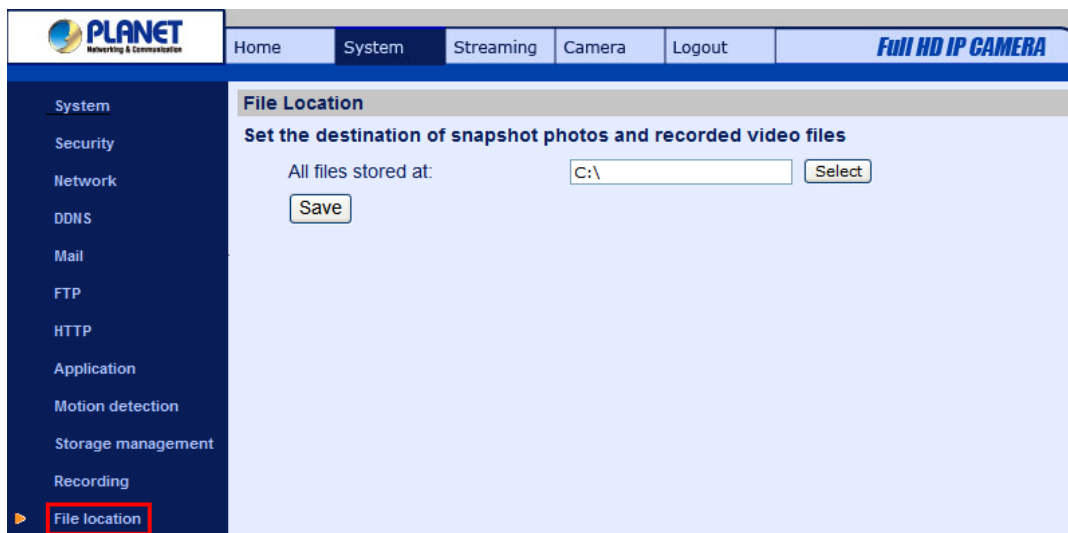

4.3.13 Iris adjustment (ICA-HM126 Series)

If there is Auto Iris Lens connected with ICA-HM126 Series, system will automatically adjust different Auto Iris Lens. Please connect the Auto Iris Lens with IP Camera properly at first, then according to the steps to carry out the adjustment works.

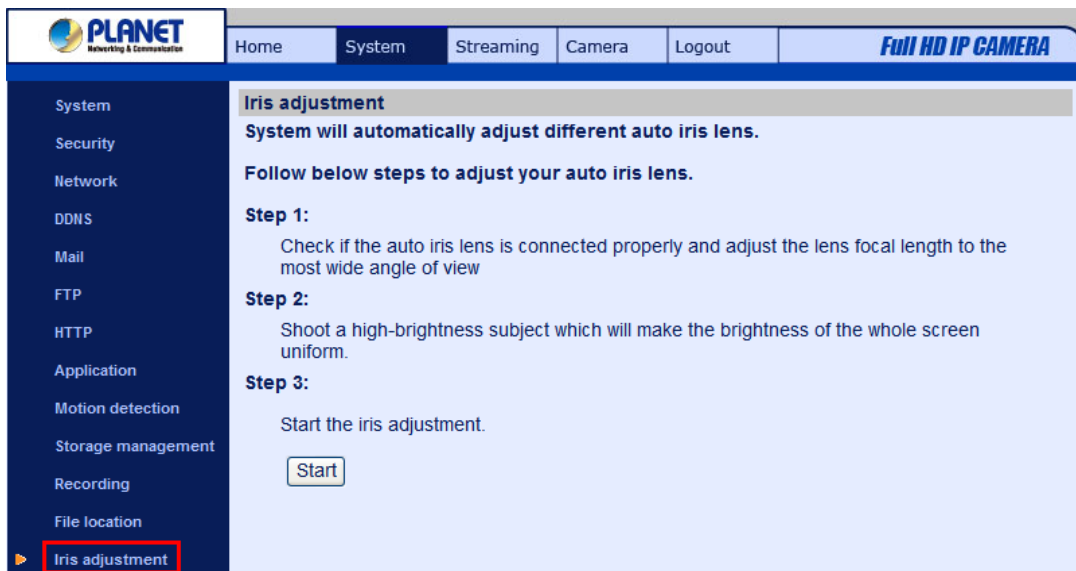

4.3.14 View Log File

Click on the link to view the system log file. The content of the file provides useful information about configuration and connections after system boot-up.

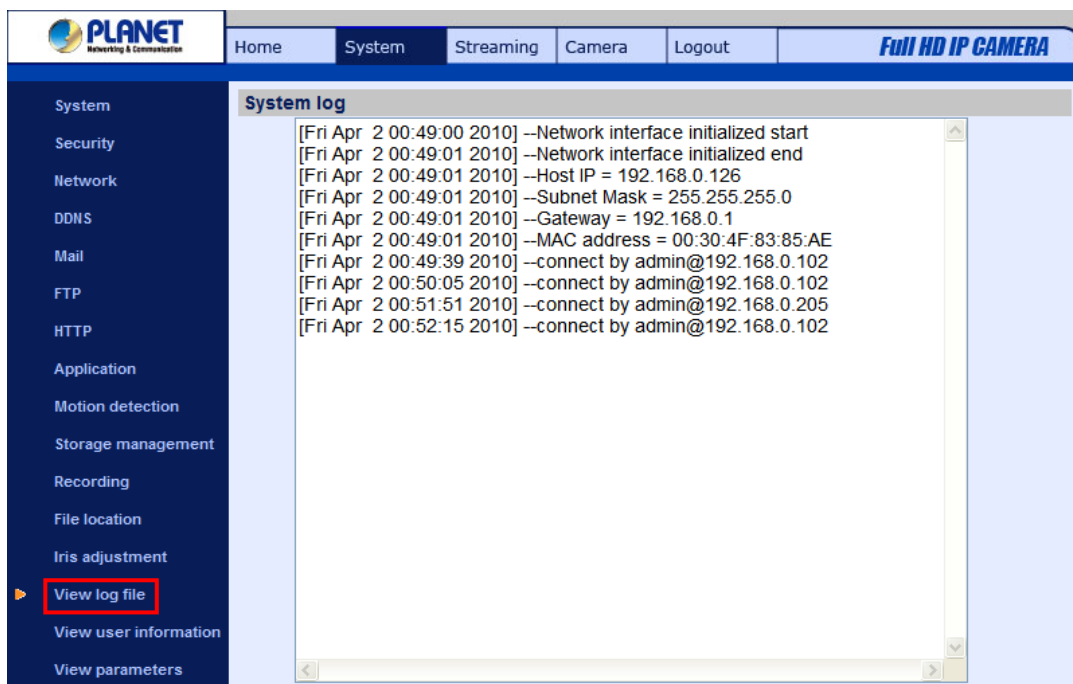

4.3.15 View User Information

The Administrator can view each added user's login information and privileges (see [4.3.2 Security](#)).

View User Login Information

All the users in the network will be listed in the "User information" zone, as shown below. As the figure below shows:

User: 4321

It indicates that one user's login username is: User and the password is: 4321.

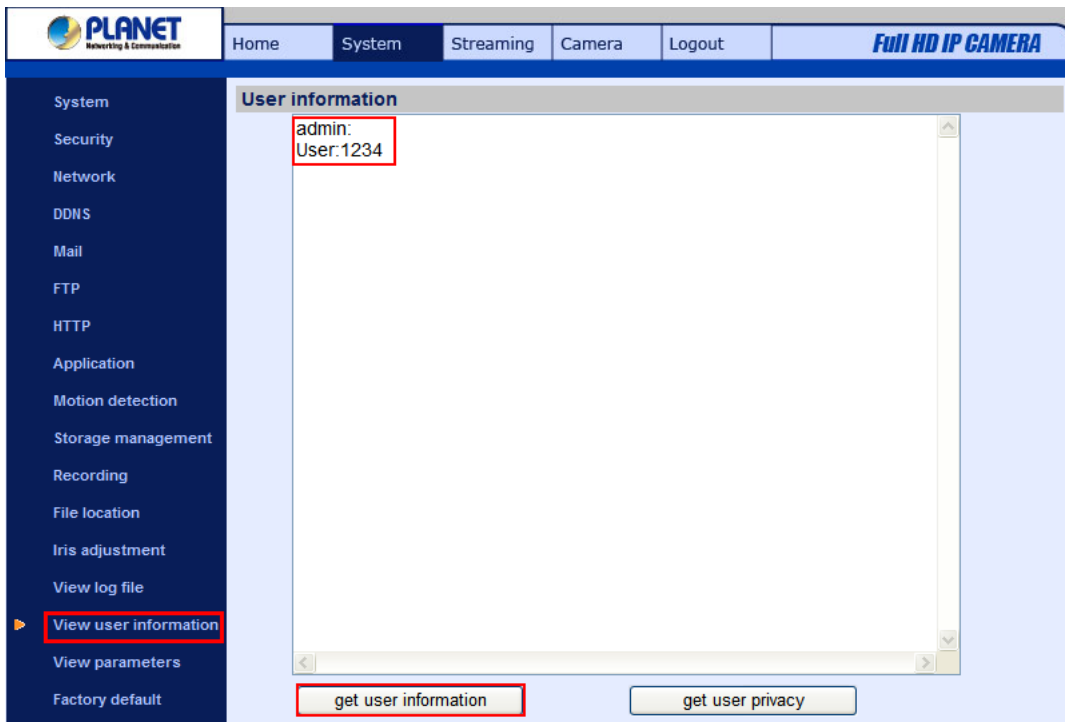

View User Privilege

Press “get user privacy” down the page, and the Administrator can view each user’s privileges.

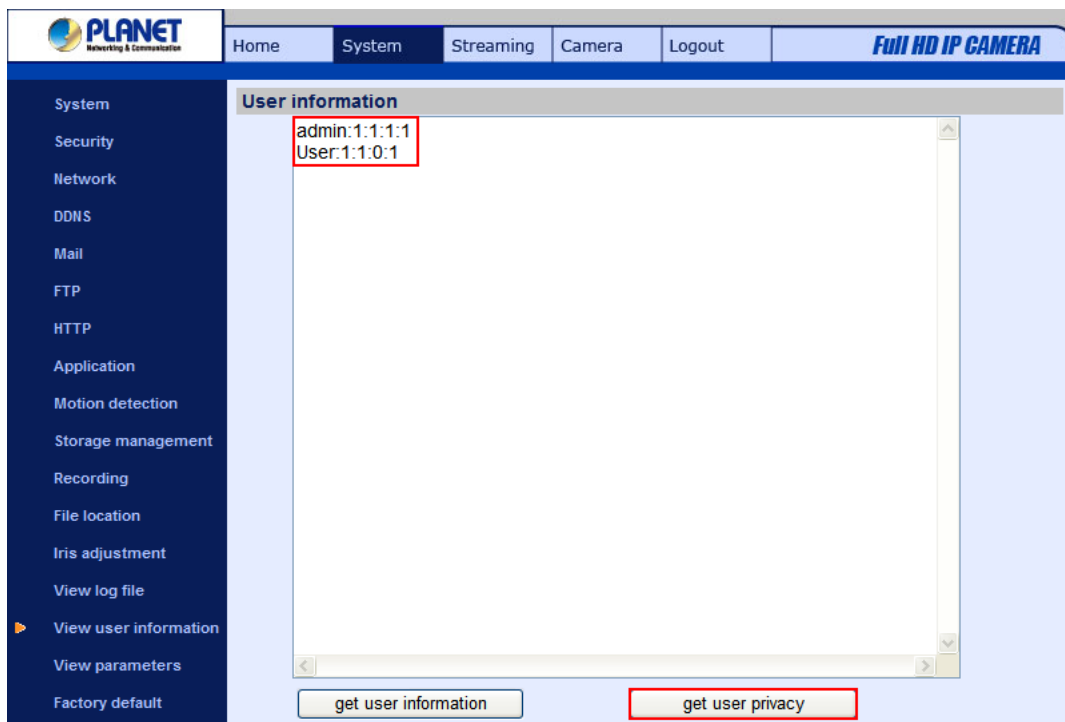

As the figure above shows:

User: 1:1:0:1

1:1:0:1= I/O access: Camera control: Talk: Listen (see [4.3.2 Security](#))

- | | |
|--|--|
| <input checked="" type="checkbox"/> I/O access | <input checked="" type="checkbox"/> Camera control |
| <input type="checkbox"/> Talk | <input checked="" type="checkbox"/> Listen |

Therefore, it denotes the user is granted privileges of I/O access, Camera control and Listen.



NOTE: The Talk option is only available for ICA-HM126 Series IP Camera.

4.3.16 View Parameters

Click on this item to view the entire system's parameter setting.

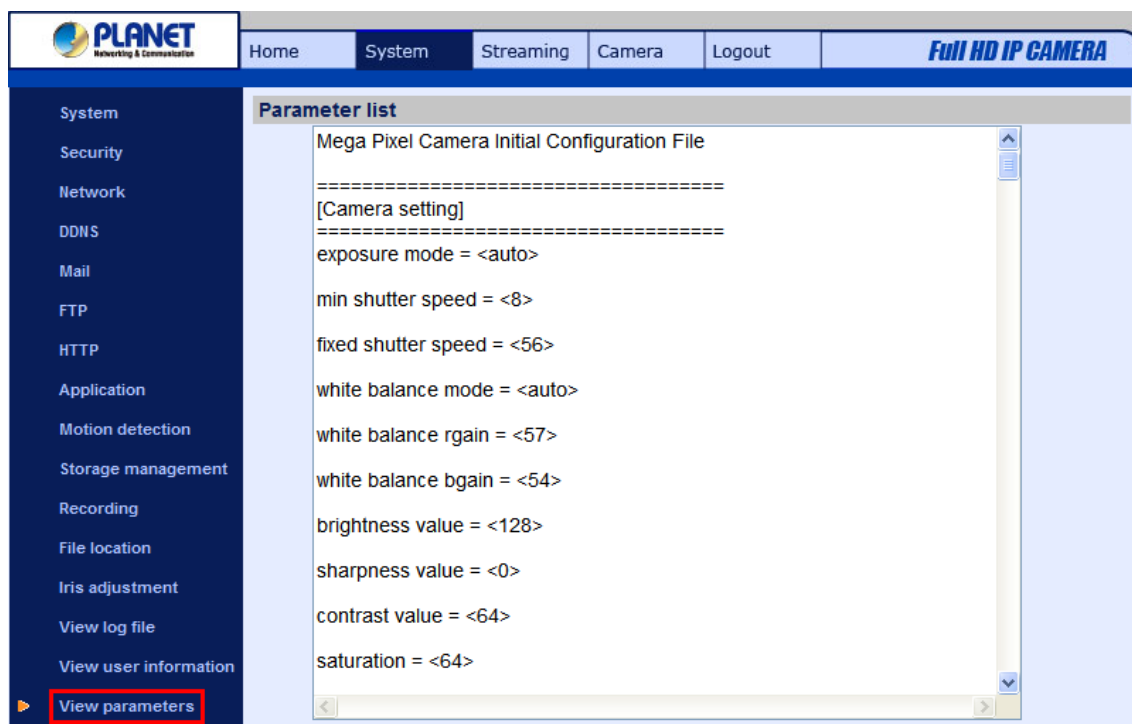

4.3.17 Factory Default

The factory default setting page is shown as below. Follow the instructions to reset the IP Camera to factory default setting if needed.

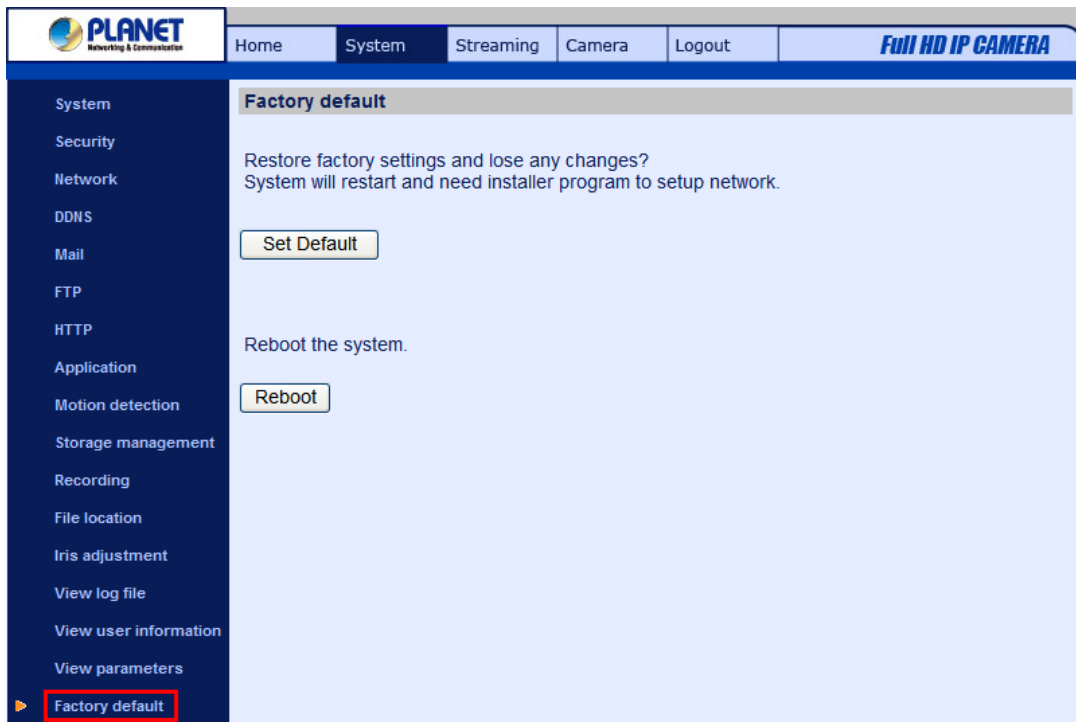

Set Default

Click on the “Set Default” button to recall the factory default settings. Then the system will restart in 30 seconds.



NOTE: The IP address will be restored to default.

Reboot

Click on the “Reboot” button, and the system will restart without changing current settings.

4.3.18 Software Version

The current software version is displayed in the software version page, which is shown as the figure below.

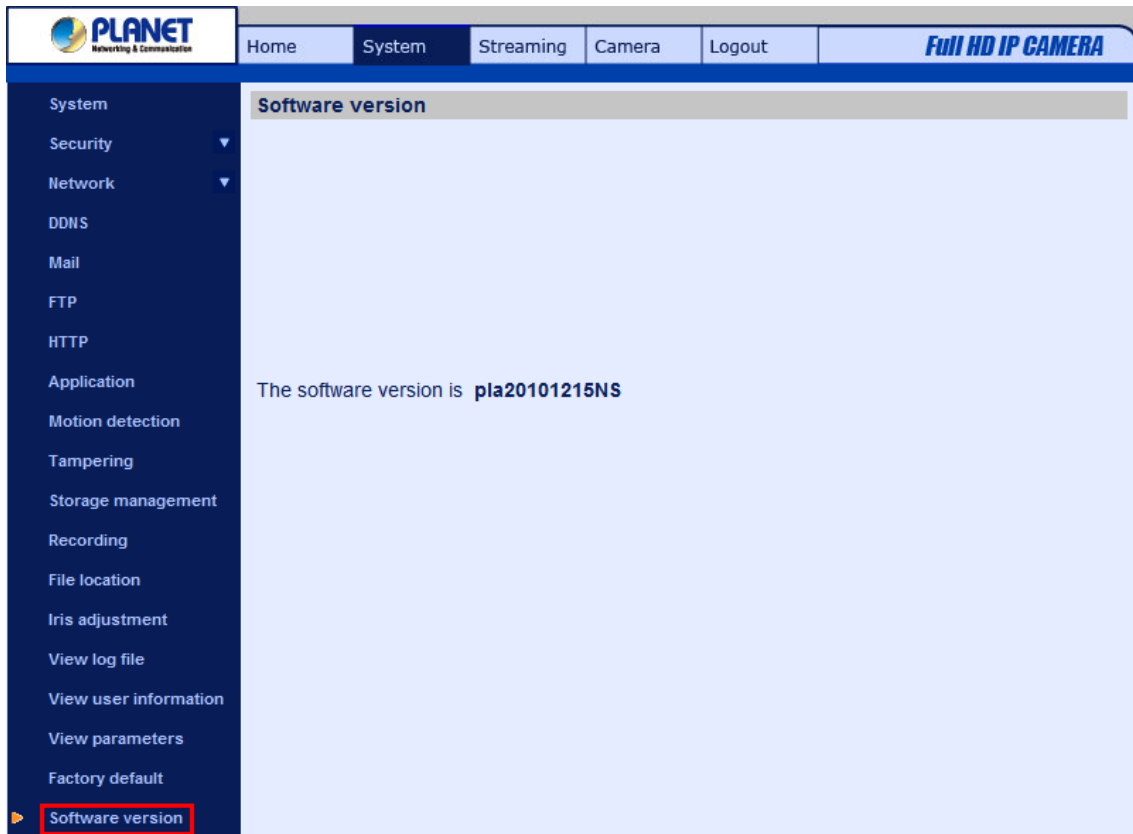

4.3.19 Software Upgrade

Software upgrade can be carried out in the “Software Upgrade” page as shown below.

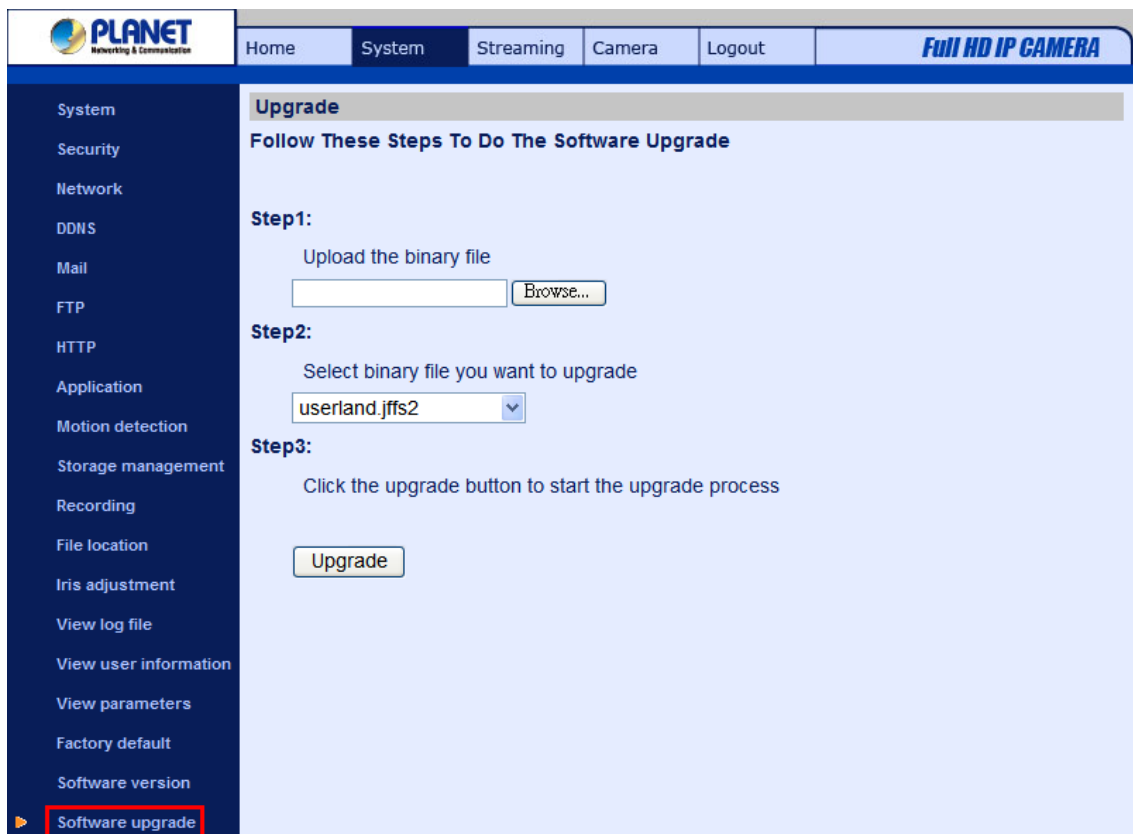



NOTE: Make sure the upgrade software file is available before carrying out software upgrade.

The procedure of software upgrade is like the following:

Step 1: Click “Browse” and select the binary file to be uploaded, ex. Userland.jffs2.

The screenshot shows the PLANET web interface for a Full HD IP Camera. The navigation menu on the left includes System, Security, Network, DDNS, Mail, FTP, HTTP, Application, Motion detection, Storage management, Recording, File location, Iris adjustment, View log file, View user information, View parameters, Factory default, Software version, and Software upgrade. The main content area is titled "Upgrade" and contains the following steps:

- Step1:** Upload the binary file. A text input field contains "C:\userland.jffs2" and a "Browse..." button is highlighted with a red box.
- Step2:** Select binary file you want to upgrade. A dropdown menu shows "userland.jffs2".
- Step3:** Click the upgrade button to start the upgrade process. An "Upgrade" button is visible.



NOTE: Do not change the upgrade file name, or the system will fail to find the file.

Step 2: Pull down the upgrade binary file list and select the file you want to upgrade; in this case, select “userland.jffs2.”

Step 3: Press “Upgrade”. The system will first check whether the upgrade file exists or not, and then begin to upload the upgrade file. Subsequently, the upgrade status bar will display on the page. When it runs to 100%, the upgrade process is finished.

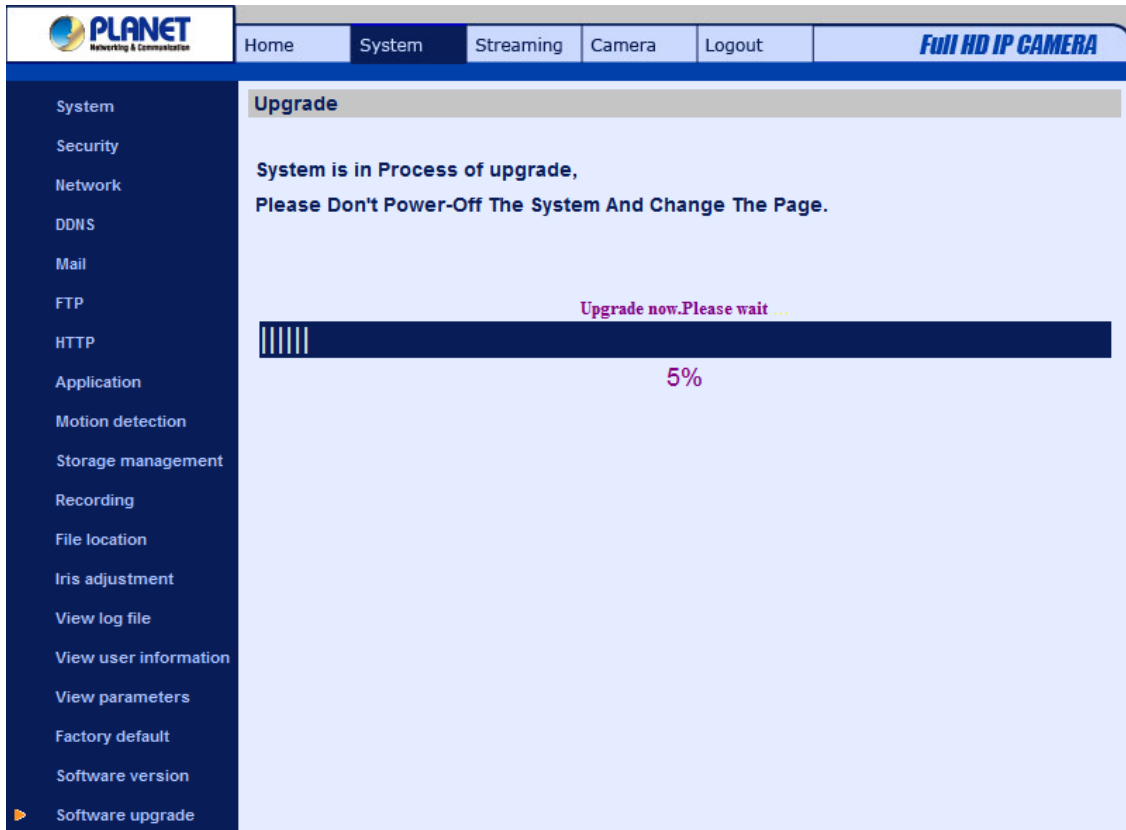

After the upgrade process is finished, the viewer will return to Home page.

Step 4: Close the video browser.

Step 5: Click “Control Panel”, and then double click “Add or Remove Programs.” In the “Currently install programs” list, select “DCViewer” and click the button “Remove” to uninstall the existing DC Viewer.

Step 6: Open a new web browser, re-login the IP Camera, and then allow the automatic download of DC Viewer.

4.3.20 Maintenance

Press “Export” button to take a backup of all of the parameters. It also could click the “Browse” button to locate the saved backup file and then click the “Upload” button. The settings will be restored to the previous configuration.

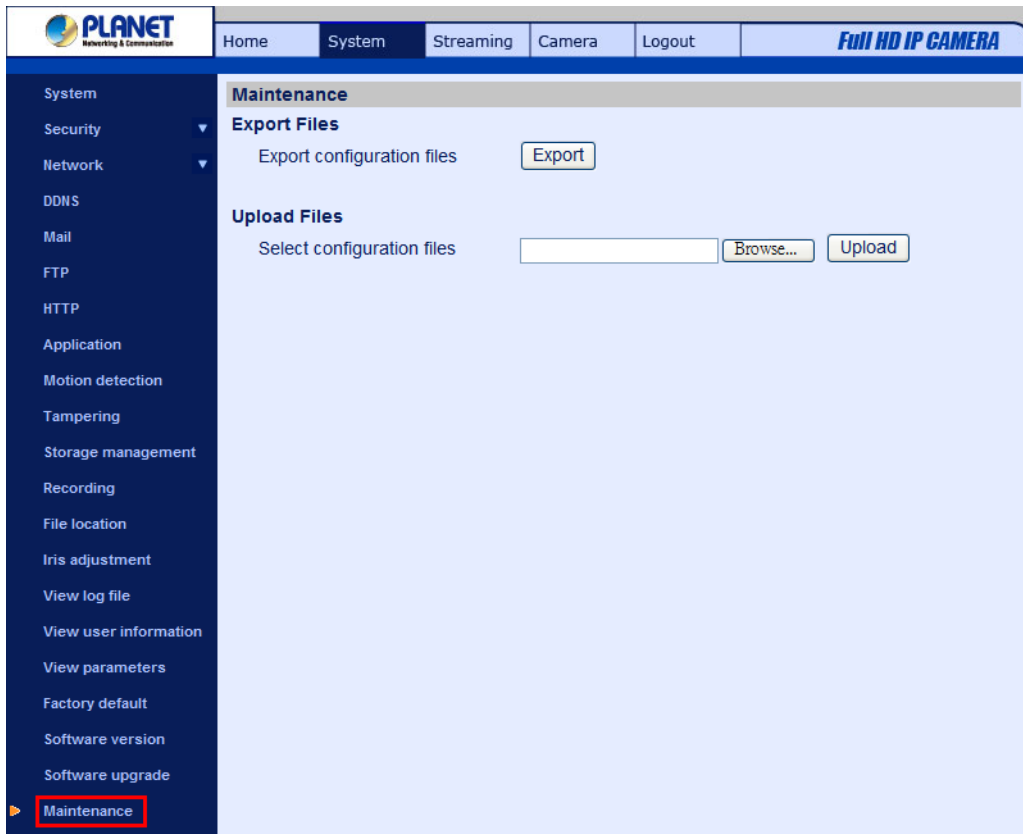

4.4 Video and Audio Streaming Settings

Press the tab "Streaming" in the top of the page, and the configurable video and audio items will display in the left column. In Streaming, the Administrator can configure specific video resolution, video compression mode, video protocol, audio transmission mode, etc. Further details of these settings will be specified in the following sections.

4.4.1 Video Resolution and Rotate Type

The IP Camera offers different resolution combination of simultaneous dual streams for optimized record and real-time monitor.

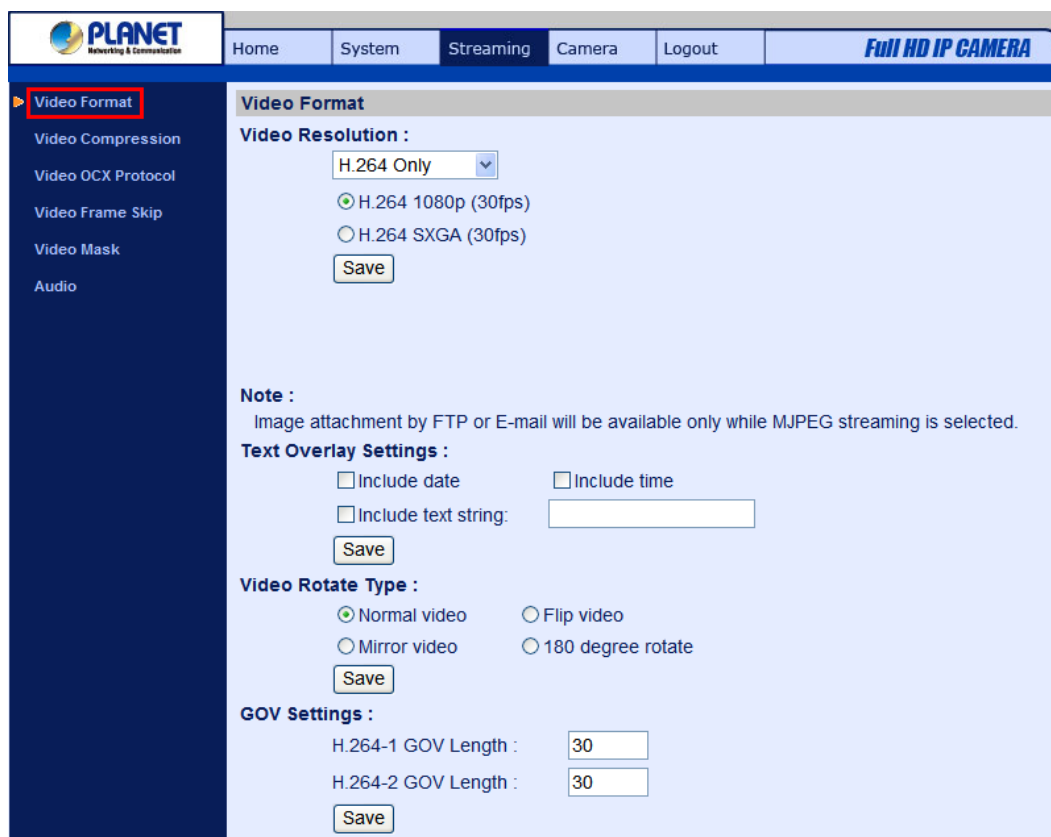

The IP Camera provides various video resolutions like the following, and click “Save” to confirm the setting.

Class	Selection
MJPEG + H.264	H.264 720p (30fps) + MJPEG 720p (30fps) H.264 720p (30fps) + MJPEG D1 (30fps) H.264 720p (30fps) + MJPEG CIF (30fps) H.264 720p (30fps) + MJPEG VGA (30fps) H.264 720p (30fps) + MJPEG QVGA (30fps)
MJPEG + BNC (Only for ICA-HM126 Series)	MJPEG 720p (30fps) + BNC Output
MJPEG Only	MJPEG 1080p (15fps) ; (ICA-HM126, ICA-HM131) MJPEG 1080p (30fps) ; (ICA-HM126R, ICA-HM131R) MJPEG SXGA (30fps)
H.264 + H.264	H.264 720p (30fps) + H.264 D1 (30fps) H.264 720p (30fps) + H.264 CIF (30fps) H.264 720p (30fps) + H.264 VGA (30fps) H.264 720p (30fps) + H.264 QVGA (30fps) H.264 720p (30fps) + H.264 QVGA (30fps Baseline)
H.264 + BNC (Only for ICA-HM126 Series)	H.264 720p (30fps) + BNC Output

H.264 Only	H.264 1080p (15fps) ; (ICA-HM126, ICA-HM131) H.264 1080p (30fps) ; (ICA-HM126R, ICA-HM131R) H.264 SXGA (30fps)
-------------------	--

Text Overlay Settings

There are some important information can be embedded into image, including date, time, and/or text.

Video Rotate Type

Users can change video display type if necessary. Selectable video rotate types include Normal, Flip, Mirror and 180 degree. Differences among these types are illustrated as below.

Suppose the displayed image of IP Camera is shown as the figure below.



To rotate the image, users can select “Flip”, for instance. Then the displayed image will be reversed as shown below.

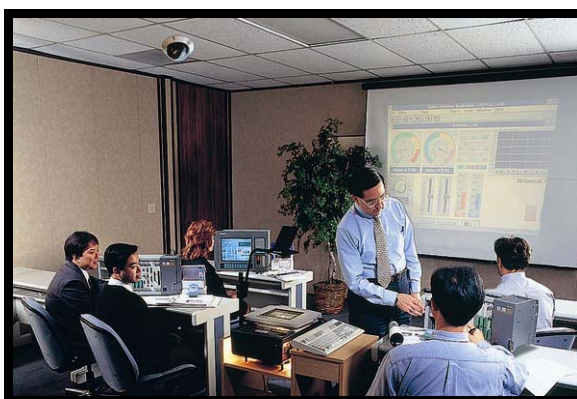

The following is descriptions for different video rotate type.

- **Flip**

If select <Flip>, the image will be rotated vertically.

- **Mirror**

If select <Mirror>, the image will be rotated horizontally.

- **180 Degree**

Selecting <180 Degree> will make the image 180° counter-/clockwise inversed.

Click “Save” to confirm the setting.

4.4.2 Video Compression

Users can select a proper MJPEG/H.264 compression mode in the video compression page (see the figure below), depending on the application.

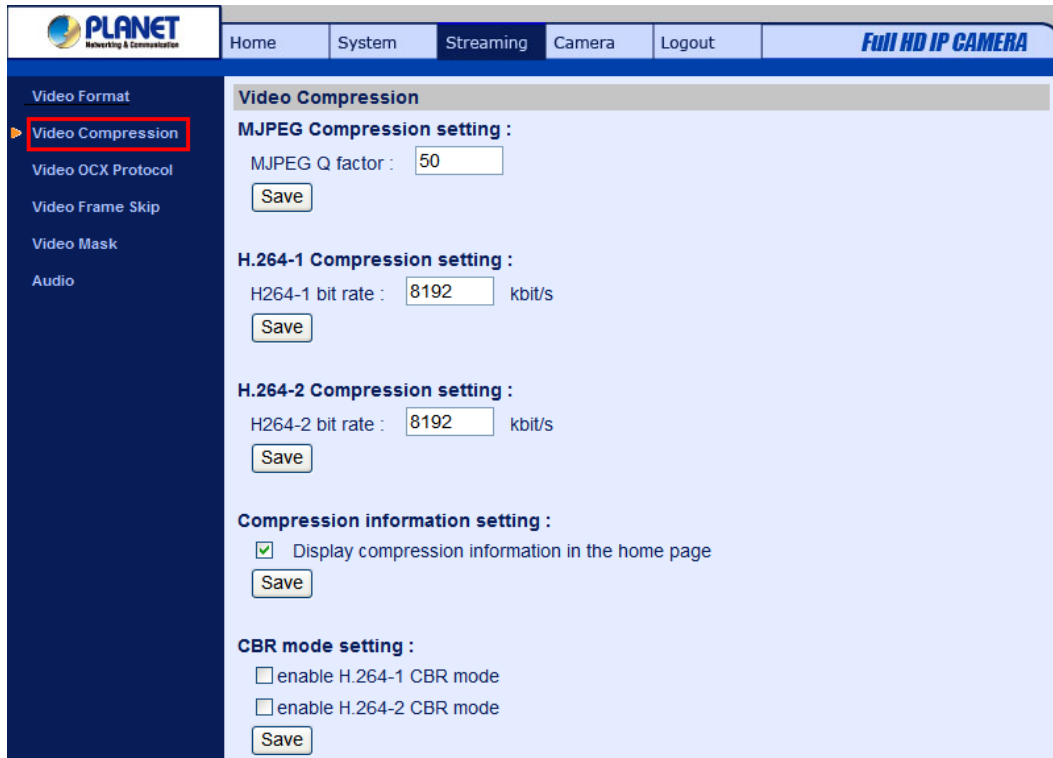

- MJPEG compression setting
- H.264-1 compression setting
- H.264-2 compression setting

Users can also decide whether to display compression information on the Home page.

Click “Save” to confirm the setting.

4.4.3 Video OCX Protocol

In the Video OCX protocol setting page, users can select RTP over UDP, RTP over TCP, RTSP over HTTP or MJPEG over HTTP, for streaming media over the network. In the case of multicast networking, users can select the Multicast mode. The page is shown as follows.

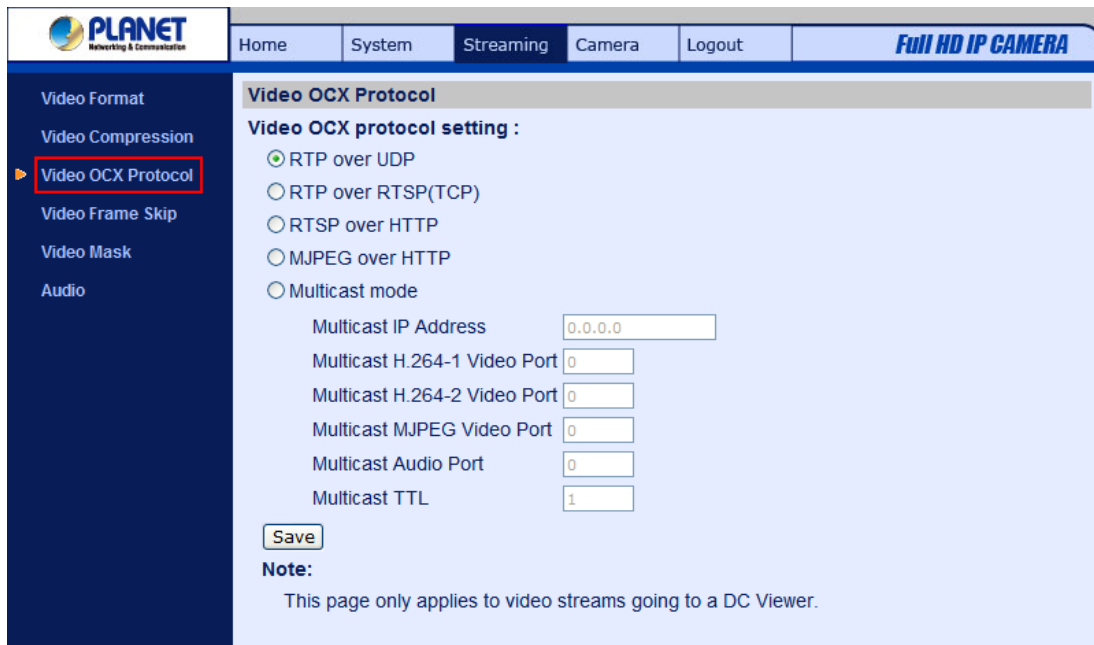

Video OCX protocol setting options include:

- RTP over UDP / RTP over RTSP(TCP) / RTSP over HTTP / MJPEG over HTTP

Select a mode according to your data delivery requirements.

- Multicast Mode

Enter all required data, including multicast IP address, H.264 video port, MJPEG video port, audio port and TTL into each blank.

Click “Save” to confirm the setting.

4.4.4 Video Frame Skip

Video frame skipping is for saving bandwidth if necessary. The setting page is shown as below.

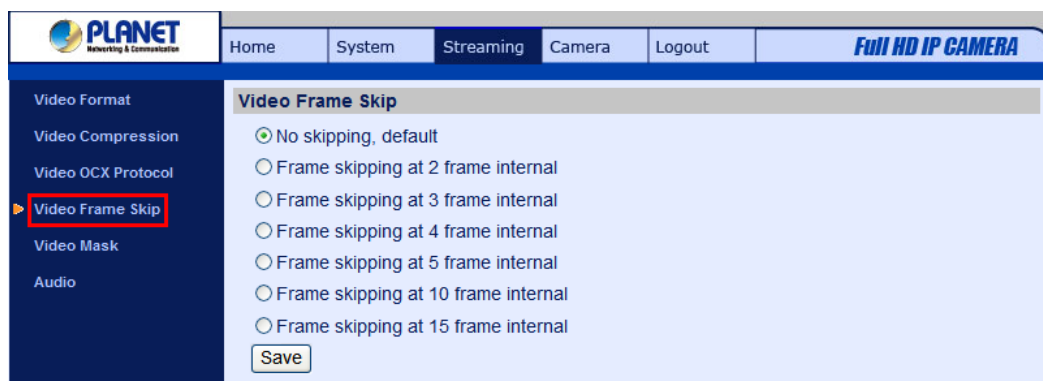

MJPEG/H.264 Frame Skip options include:

- No skipping, default
- Frame skipping at 2 frame internal (lowest frame loss rate)

- Frame skipping at 3 frame internal
- Frame skipping at 4 frame internal
- Frame skipping at 5 frame internal
- Frame skipping at 10 frame internal
- Frame skipping at 15 frame internal (highest frame loss rate)



NOTE: Higher frame skipping rate will decrease video smoothness.

4.4.5 Audio Mode and Bit Rate Settings

The audio setting page is show as below. In the Audio page, the Administrator can select one transmission mode and audio bit rate.

Transmission Mode

- Full-duplex (Talk and Listen simultaneously)

In the Full-duplex mode, the local and remote sites can communicate with each other simultaneously, i.e. both sites can speak and be heard at the same time.



NOTE: This option is only available in the ICA-HM126 Series IP Camera.

- Half-duplex (Talk or Listen, not at the same time)

In the Half-duplex mode, the local/remote site can only talk or listen to the other site at a time.



NOTE: This option is only available in the ICA-HM126 Series IP Camera.

- Simplex (Talk only)

In the Talk only Simplex mode, the local/remote site can only talk to the other site.



NOTE: This option is only available in the ICA-HM126 Series IP Camera.

Simplex (Listen only)

In the Listen only Simplex mode, the local/remote site can only listen to the other site.

- Disable

Select the item to turn off the audio transmission function.

Server Gain Setting

Set the audio Input / Output gain levels for sound amplification. Audio gain values are adjustable from 1 to 6. Set the audio gain to “Mute” will turn off the sound.

Bit Rate

Selectable audio transmission bit rate include 16 kbps (G.726), 24 kbps (G.726), 32 kbps (G.726), 40 kbps (G.726), uLAW (G.711) and ALAW (G.711). Both uLAW and ALAW signify 64 kbps but in different compression formats. Higher bit rate will let higher audio quality and require bigger bandwidth.

Click “Save” to confirm the setting.

4.5 Camera Settings

The figure below is the camera configuration page. Details of each parameter setting are described as follows.



NOTE: Camera settings and buttons below the screen vary among different types of camera.

4.5.1 Exposure Setting

The Exposure pull-down menu is shown as follows:

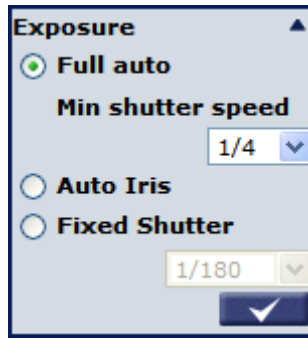

The exposure is the amount of light received by the image sensor and is determined by the width of lens diaphragm opening (iris adjustment), the amount of exposure by the sensor (shutter speed) and other exposure parameters. With this item, users can define how the Auto Exposure function works.

Each exposure mode is specified as follows:

Full Auto Mode

In this mode, the camera's Shutter Speed, IRIS and AGC (Auto Gain Control) control circuits work together automatically to get consistent video output level. The maximum shutter speed is adjustable from 1/30 to 1 sec.

Fixed Shutter Mode

In this mode, fixed shutter speed could be selected from the dropdown menu. The shutter speed range is from 1/10000 to 1 sec. with 19 options. Users could select suitable shutter speed according to the environmental illumination.

4.5.2 White Balance Setting

The White Balance pull-down menu is shown as follows:

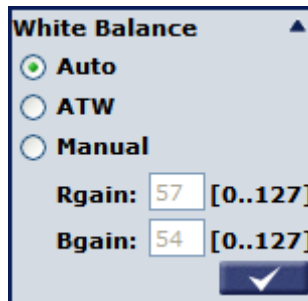

A camera needs to find reference color temperature, which is a way of measuring the quality of a light source, for calculating all the other colors. The unit for measuring this ratio is in degree Kelvin (K). Users can select one of the White Balance Control modes according to the operating environment. The following table shows the color temperature of some light sources for reference.

Light Sources	Color Temperature in K
Cloudy Sky	6,000 to 8,000
Noon Sun and Clear Sky	6,500
Household Lighting	2,500 to 3,000
75-watt Bulb	2,820
Candle Flame	1,200 to 1,500

Auto Mode

In this mode, white balance works within its color temperature range and calculates the best-fit white balance.

Manual Mode

In this mode, users can change the White Balance value manually through adjusting the R gain and B gain. Press <SET> to confirm the new setting.

4.5.3 Brightness Setting

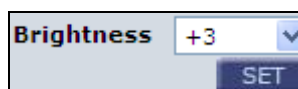

Users can adjust the image's brightness by adjusting the item. The value of Backlight is adjustable from -12 (dim) ~ +13 (brightest). Press <SET> to confirm the new setting.

4.5.4 Sharpness Setting

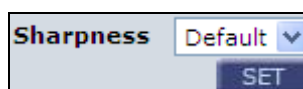

Increasing the sharpness level can make the image looked sharper; especially enhance the object's edge. The value of sharpness is adjustable from +1 ~ +15 (sharpest) besides to default value. Press <SET> to confirm the new setting.

4.5.5 Contrast Setting

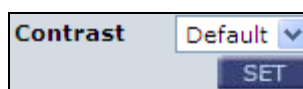

Users can correct the contrast of the entire image via adjusting the Contrast level, ranging from -6 ~ +19.

4.5.6 Saturation

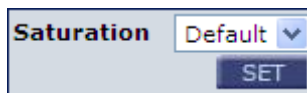

Users can adjust the saturation of color components in an image through the Saturation function, which is adjustable from -6 ~ +19.

4.5.7 Hue

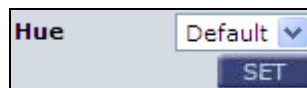

Users can adjust the hue of color components in an image through the Hue function, which is adjustable from -12 ~ +13.

4.5.8 TV System Setup

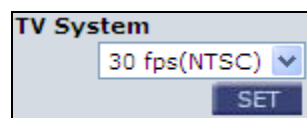

Select the video format that matches the present TV system.

4.6 Logout

Press the tab “Logout” in the top of the page, and the login window will pop up. This enables login with another user name.

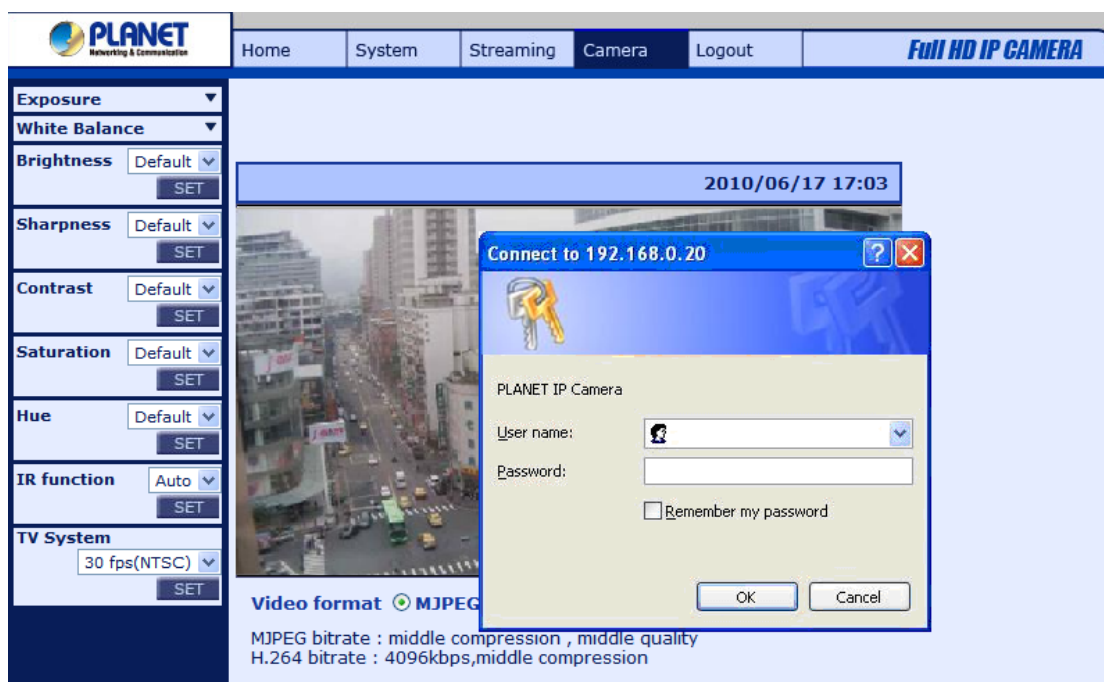

Appendix A: IP Camera Specifications

Product	ICA-HM126	ICA-HM126R
Video Specification		
Image Sensor	1/2.7" Progressive CMOS	
Lens	Focal Length 4.0 mm, F1.5, CS mount type	
Minimum illumination	0.2 Lux @ F1.2	
Video Resolution	H.264 1080p / 720p M-JPEG 1080p / 720p / D1 / CIF	
Frame Rate	15fps for 1080p 30fps for other resolutions	30fps for all resolutions
Shutter Speed	1 ~ 1/10000 sec	
White Balance	Manual / ATW (1500 ~ 15000K)	
View Angle (Horizontal / Vertical)	66 / 52 Degree	
Scan Method	Progressive	
Video Encoder	H.264 / M-JPEG	
Rate Control	VBR (Variable Bit Rate)	
Image Control	AWB, AES	
ICR	Auto, On, Off	
Audio Specification		
Audio Codec	G.711, G.726	
Audio I/O	Line in/MIC in, Line out,	
Audio Streaming	One-Way or Two-Way	
Network and Configuration		
Network Standard	IEEE 802.3 / IEEE 802.3u / IEEE 802.3af	
Network Protocol	TCP/IP, UDP, RTP, RTSP, HTTP, ICMP,FTP, SMTP, DHCP, IGMP	
Browser / Software	Microsoft © Internet Explorer 6.0 or later, Cam Viewer 3 Lite/Pro	
Interface Specifications		
Network	1 x RJ-45 10/100 Base-TX	
Lens Mounting	CS mount	
Storage Interface	Mirco-SD, SDHC support	
Video Out	1 x BNC video output	
Audio Out	1 x audio output (3.5 mm)	
Auto Iris	1 x Auto Iris connector, DC Drive	
Alarm	4 pins terminal block, pitch 3.5mm	
Environment Specifications		
Power Requirement	12V DC, 1 A, IEEE 802.3af	
Dimension (W x D x H)	82 x 125 x 52 mm	
Weight	360g	
Power Consumption	3.8W max.	
Operating Temperature	0 ~ 50 Degree C	
Operating Humidity	10 ~ 90% (non-condensing)	
Emission	CE, FCC	

Product	ICA-HM131	ICA-HM131R
Video Specification		
Image Sensor	1/2.7" Progressive CMOS	
Lens	Focal Length 4.0 mm, F1.5	
Minimum illumination	0.2 Lux @ F1.2	
View Angle (Horizontal / Vertical)	66 / 52 Degree	
Scan Method	Progressive	
Video Encoder	H.264 / M-JPEG	
Rate Control	VBR (Variable Bit Rate)	
Video Resolution	H.264 1080p / 720p M-JPEG 1080p / 720p / D1 / CIF	
Frame Rate	15fps for 1080p 30fps for other resolutions	30fps for all resolutions
Image Control	AWB, AES	
Audio Specification		
Audio Codec	G.711, G.726	
Audio In	Internal Microphone	
Network and Configuration		
Network Interface	1 x RJ-45	
Network Standard	IEEE 802.3 / IEEE 802.3u	
Network Protocol	TCP/IP, UDP, RTP, RTSP, HTTP, ICMP,FTP, SMTP, DHCP, IGMP	
Browser / Software	Microsoft ® Internet Explorer 6.0 or later, Cam Viewer 3 Lite/Pro	
Motion Detection	10 areas definable	
Environment Specifications		
Power Requirement	IEEE 802.3af	
Dimension (W x D x H)	Φ110 x 50 mm	
Weight	180g	
Power Consumption	3.8W max.	
Operating Temperature	0 ~ 50 Degree C	
Operating Humidity	10 ~ 90% (non-condensing)	
Emission	CE, FCC	

Appendix B: Internet Security Settings

If ActiveX control installation is blocked, please either set Internet security level to default or change ActiveX controls and plug-ins settings.

Internet Security Level: Default

Step 1: Start the Internet Explorer (IE).

Step 2: Select <Tools> from the main menu of the browser. Then Click <Internet Options>.

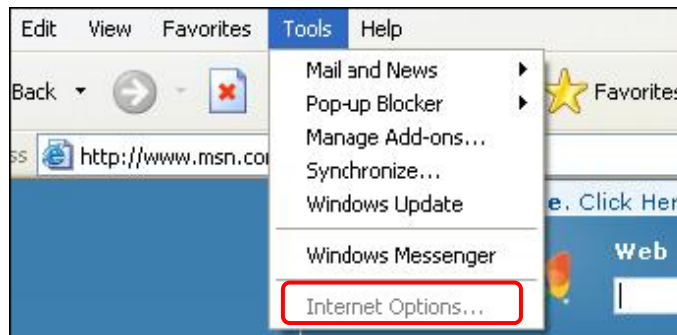

Step 3: Click the <Security> tab, and select <Internet>.

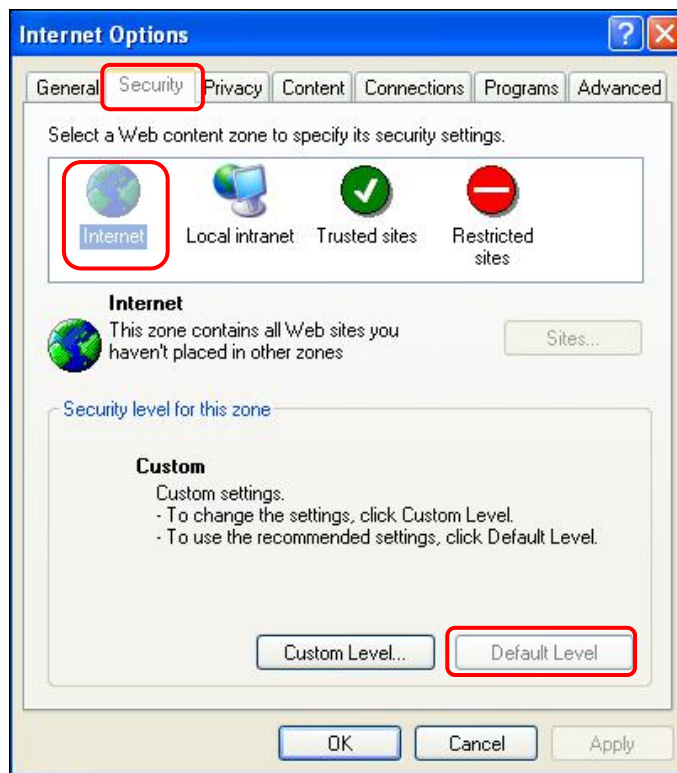

Step 4: Down the page, press “Default Level” (see the figure above) and click “OK” to confirm the setting. Close the browser window, and open a new one later when accessing the IP Camera.

ActiveX Controls and Plug-ins Settings

Step 1~3: Refer to the previous section above.

Step 4: Down the page, press “Custom Level” (see the figure below) to change ActiveX controls and plug-ins settings.

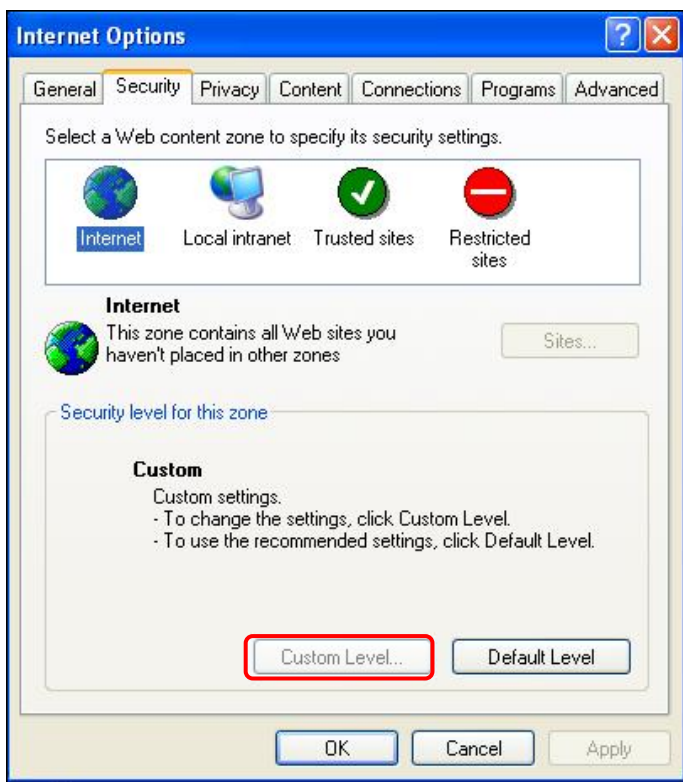

The Security Settings screen is displayed as below:

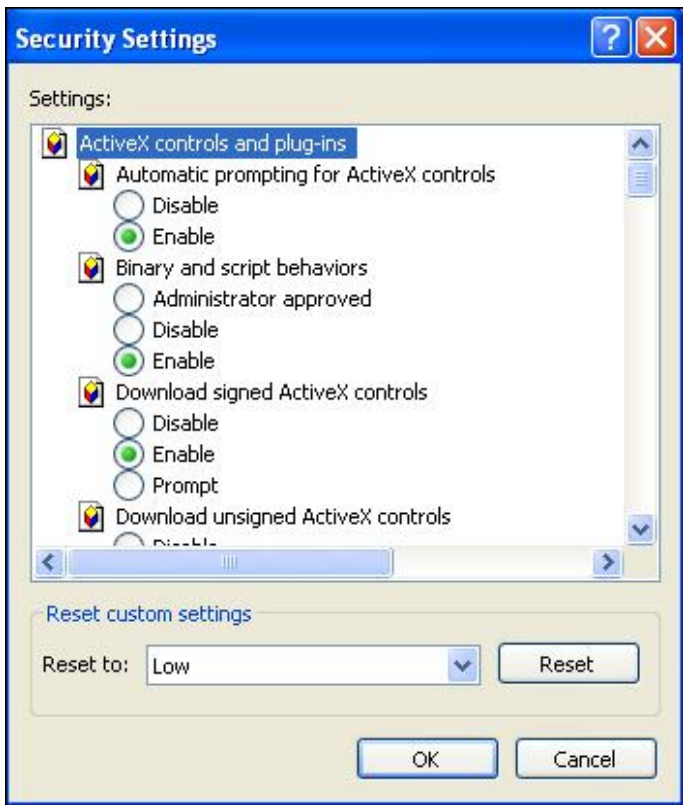

Step 5: Under “ActiveX controls and plug-ins”, set ALL items (as listed below) to <Enable> or <Prompt>.

- | |
|--|
| <p>ActiveX controls and plug-ins settings:</p> <ol style="list-style-type: none">1. Automatic prompting for ActiveX controls2. Binary and scrip behaviors3. Download signed ActiveX controls4. Download using ActiveX controls5. Initialize and script ActiveX not marked as safe6. Run ActiveX controls and plug-ins7. Script ActiveX controls marked safe for scripting |
|--|

Step 6: Click <OK> to accept the settings and close the <Security> screen.

Step 7: Click <OK> to close the Internet Options screen.

Step 8: Close the browser window, and restart a new one later for accessing the IP Camera.

Appendix C: DC Viewer Download Procedure

The procedure of DC Viewer software download is specified as follows.

Step 1: In the DC Viewer installation page, click “Next” for starting installing.

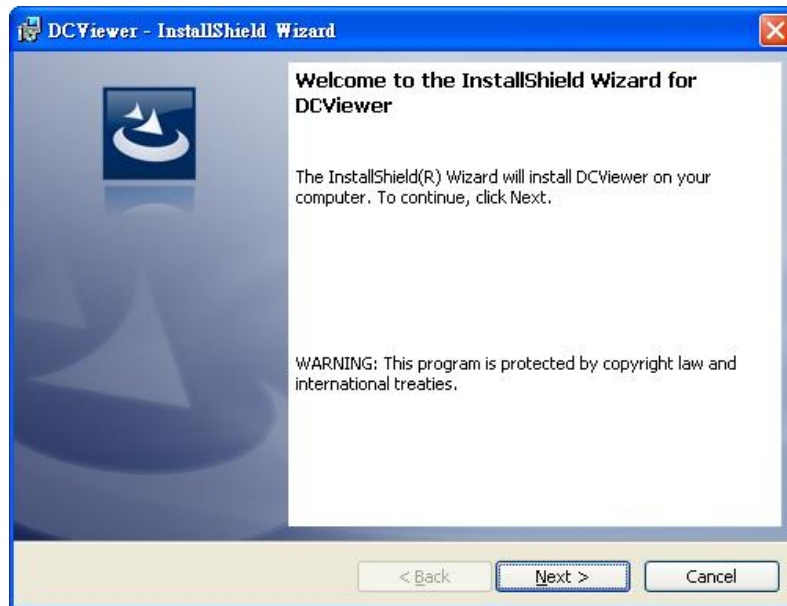

Step 2: Setup starts. Please wait for a while until the loading bar runs out.



Step 3: Click “Finish” to close the DC Viewer installation page.

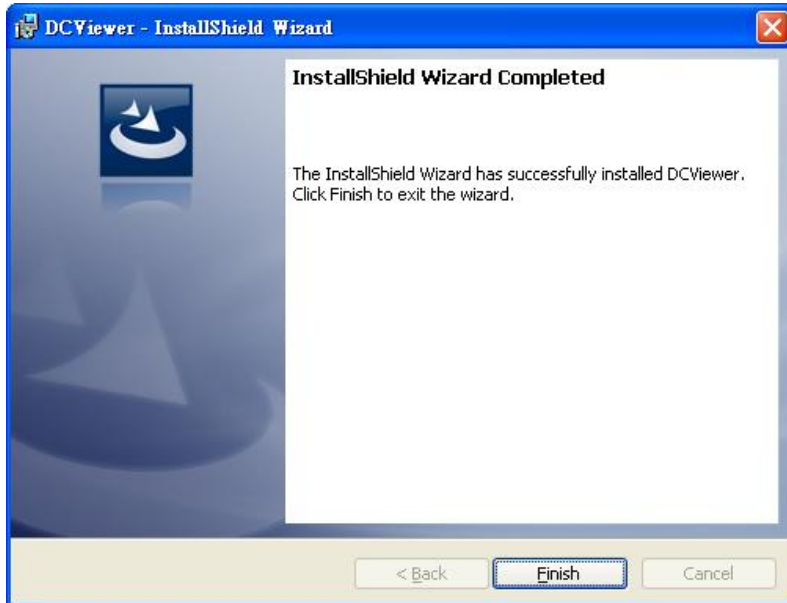

Then, the IP Camera's Home page will display as follows:



Appendix D: Frequently Asked Questions

Q1 [ICA-HM126/131 Series] How can I know the IP address of IP camera?

Ans: The default IP address is 192.168.0.20, and you could use the **Device Search** utility on the bundled CD to obtain the current IP address of IP camera. Please refer to the user's manual for more detail information.

Q2 [ICA-HM131/131R] How to supply power to ICA-HM131/131R?

Ans: The LAN socket of IP Camera is compliant with IEEE802.3af standard PoE interface, and IP Camera is necessary supplied power through PoE Switch/Hub device.

Q3 [ICA-HM131/131R] How to adjust the focus and angle of lens?

Ans: Use the L-type spanner in the bundled package to unscrew the cover. Loosen the focus fixed screw, and rotate the lens counter-/clockwise to adjust focus; loosen the tilt fixed screw, and adjust the camera's tilt angle. You could get detail descriptions on the user's manual.

Q4 [ICA-HM131/131R] How to reset IP camera to default setting?

Ans: The Reset button at the side of lens. Use the L-type spanner in the bundled package to unscrew the cover at first, and press the button with a proper tool to default setting.

Q5 [ICA-HM126/126R] How to reset IP camera to default setting?

Ans: The Reset button at the rear side of camera, press the button with a proper tool to default setting.

Q6 [ICA-HM126/131 Series] After upgraded firmware, why can't see the picture for MJPEG video format via web browser?

Ans: That because the system with the newer video formats, and the PC need to install the newer DC Viewer software to appear the video on PC properly.

Ans: Please go to "Control Panel -> Add or Remove Programs" to remove old DC Viewer software at first. Then connect to IP camera via web browser and it will prompt to install the new DC Viewer software in to PC.

EC Declaration of Conformity

For the following equipment:

*Type of Product : Full HD H.264 Box IP Camera / Full HD Real-Time H.264 Box IP Camera
*Model Number : ICA-HM126 / ICA-HM126R

* Produced by:

Manufacturer's Name : **Planet Technology Corp.**
Manufacturer's Address : 11F, No. 96, Min Chuan Road, Hsin Tien,
Taipei, Taiwan, R.O.C.

is herewith confirmed to comply with the requirements set out in the Council Directive on the Approximation of the Laws of the Member States relating to Electromagnetic Compatibility (2004/108/EC).

For the evaluation regarding the Electromagnetic Compatibility, the following standards were applied:

EN 55022	(2006 + A1: 2007)
EN 61000-3-2	(2006)
EN 61000-3-3	(2008)
EN 50130-4	(1995 + A1: 1998 + A2: 2003)
EN 61000-4-2	(1995 + A1: 1998 + A2: 2001)
EN 61000-4-3	(2006 + A1: 2008)
EN 61000-4-4	(2004)
EN 61000-4-5	(2006)
EN 61000-4-6	(2007)
EN 61000-4-11	(2004)

Responsible for marking this declaration if the:

Manufacturer **Authorized representative established within the EU**

Authorized representative established within the EU (if applicable):

Company Name: Planet Technology Corp.

Company Address: 11F, No.96, Min Chuan Road, Hsin Tien, Taipei, Taiwan, R.O.C.

Person responsible for making this declaration

Name, Surname Jonas Yang

Position / Title : Product Manager

Taiwan
Place

1st July, 2010
Date

Jonas
Legal Signature

PLANET TECHNOLOGY CORPORATION

EC Declaration of Conformity

For the following equipment:

*Type of Product : Wired H.264 Mega-Pixel IP Camera

*Model Number : ICA-HM131 / ICA-HM131R

* Produced by:

Manufacturer's Name : **Planet Technology Corp.**

Manufacturer's Address : 11F, No. 96, Min Chuan Road, Hsin Tien,
Taipei, Taiwan, R.O.C.

is herewith confirmed to comply with the requirements set out in the Council Directive on the Approximation of the Laws of the Member States relating to Electromagnetic Compatibility (2004/108/EC).

For the evaluation regarding the Electromagnetic Compatibility, the following standards were applied:

EN 55022	(2006 + A1: 2007, Class A)
EN 61000-3-2	(2006)
EN 61000-3-3	(1995 + A1: 2001 + A2: 2005)
EN 50130	(1995 + A1: 1998 + A2: 2003)
IEC 61000-4-2	(1995 + A1: 1998 + A2: 2000)
IEC 61000-4-3	(2006)
IEC 61000-4-4	(2004)
IEC 61000-4-5	(2005)
IEC 61000-4-6	(2003 + A1: 2004 + A2: 2006)
IEC 61000-4-11	(2004)

Responsible for marking this declaration if the:

Manufacturer **Authorized representative established within the EU**

Authorized representative established within the EU (if applicable):

Company Name: **Planet Technology Corp.**

Company Address: **11F, No.96, Min Chuan Road, Hsin Tien, Taipei, Taiwan, R.O.C.**

Person responsible for making this declaration

Name, Surname **Jonas Yang**

Position / Title : **Product Manager**

Taiwan
Place

1st July, 2010
Date

Jonas
Legal Signature

PLANET TECHNOLOGY CORPORATION